

# GEMS



**MORGAN PLUS 8**

1998 – 2004

Engine Management System  
**Operations and Maintenance**

# Contents

Title	Page
■ Introduction	3
■ Fuel Injection Basics	7
■ Introduction to GEMS	11
■ General Considerations	17
■ Tools and Precautions	20
■ Morgan-Specific Differences	22
■ Known Failures	25
■ GEMS Diagnostic Tools	29
■ Engine Control Module	37
■ EMS Components	46
■ Diagnostics	74
■ Maintenance Procedures	79
■ RovacomLite	88
■ Autotap	100
■ OBD Generic Trouble Codes	105
■ GEMS Specific Trouble Codes	107
■ Copyright and Disclaimers	109

# GEMS

## Introduction

# Introduction

- This presentation covers the Lucas-SAGEM GEMS Engine Control Module (ECM), which, together with the sensors and actuators, form the Engine Management System (EMS). It was installed on Morgan Plus-8 models from 1998 to 2004 fitted with 4.0 V-8 engines.
- GEMS was introduced on chassis number R12451 with the 50D engine, and the only main change occurred at chassis number R12511 with the change to the 87D engine, when the “advanced evaps” fuel evaporation control system was introduced in order to comply with the current On-Board Diagnostic (OBD-II) North American Specifications (NAS) certification standards.
- The knock sensors were removed at the same time, and a new program used in the ECM. These are contained in PROMs (see over) specially made for MMC, and have serial numbers 9660 for model year 2000 and 9664 for Model year 2002 – other year/serials are not known.
- The Lucas 10AS security system is also fitted. It is very sophisticated and can accept multiple analogue and discrete sensor inputs, warn of catalyst overheating, as well as control alarms and interior lights – but only the engine disable (secure immobilization) function is used in the Plus 8. It is controlled by a remote “PLIP”, and when disarmed it sends a data word to the GEMS which compares it with a stored data word – if they match GEMS will allow the engine to start.

# Component Locations

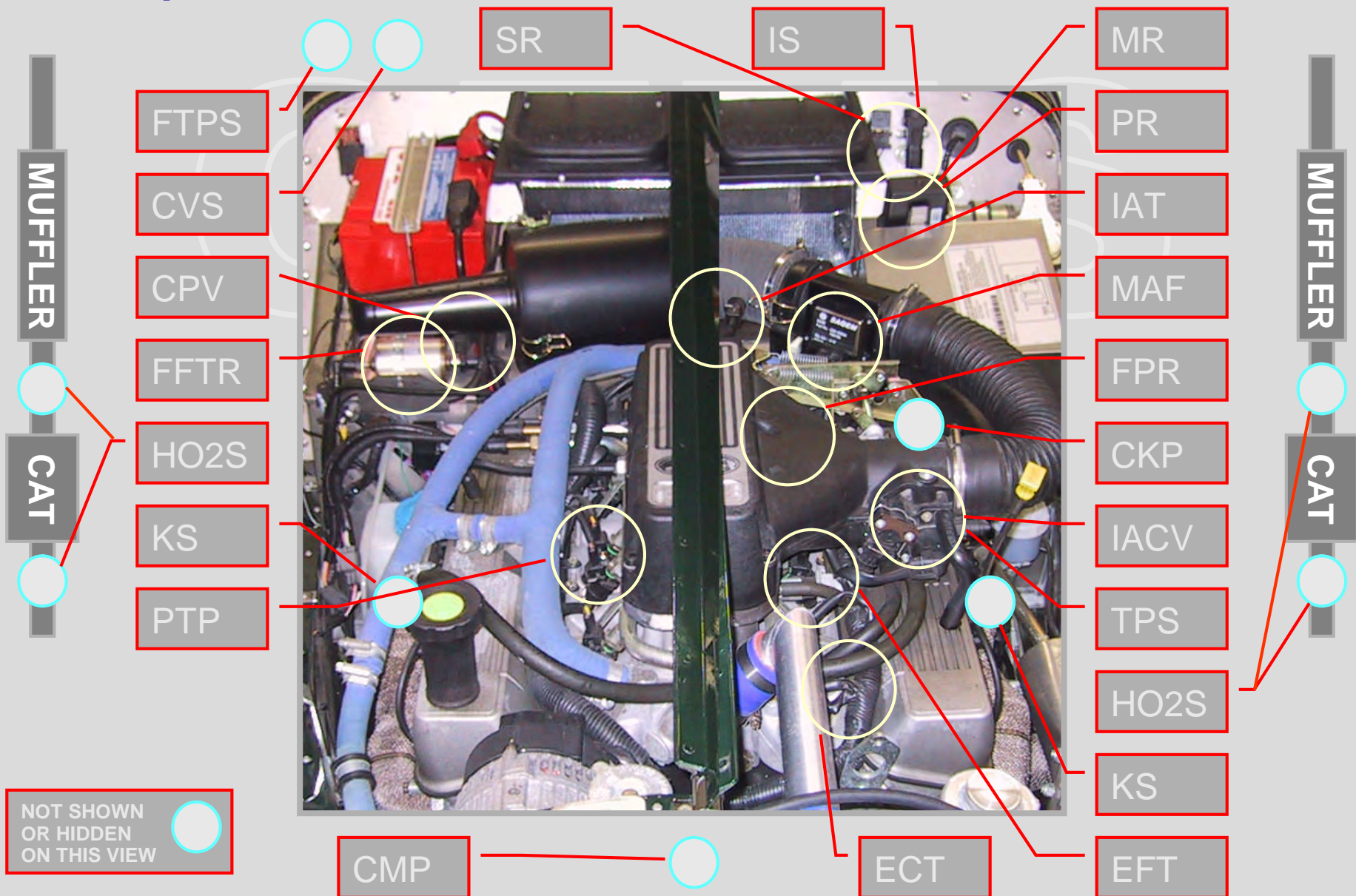

# Abbreviations

Abbreviation	Meaning
CARB	California Air Resource Board
CKP	Crankshaft Position Sensor
CMP	Camshaft Position Sensor
CPV	Canister Purge Valve
CVS	Canister Vent Solenoid
ECM	Engine Control Module
ECT	Engine Coolant Temperature
EFT	Engine Fuel Temperature
EMS	Engine Management System
PROM	Programmable Read-Only Memory
FFTR	Fuel Filter
FPR	Fuel Pressure Regulator
HO2S	Heated O <sub>2</sub> Sensor
IACV	Inlet Air Control Valve

Abbreviation	Meaning
IAT	Inlet Air temperature
IS	Inertia Switch
KS	Knock Sensor
LR	Land Rover
MAF	Mass Air Flow
MR	Main relay
PTP	Pressure Test Point
PR	Pump Relay
OBD-II	On-Board Diagnostics II
OBDM	On-Board Diagnostic Monitor
MRM	Multi-Function Relay Module
SR	Starter Relay
TPS	Throttle Position Sensor
FTPS	Fuel Tank Pressure Sensor

# GEMS

## Fuel Injection Basics

# Fuel Injection Basics

- GEMS (and most) Fuel Injection systems use the same basic layout - a fuel pump immersed in the tank pressurizes injectors attached to a fuel rail, with the pressure at the injectors controlled by a regulator. The regulator has a connection to manifold vacuum, and maintains a constant pressure differential between the fuel rail and the manifold. Fuel is always circulated through the system and excess fuel is returned to the tank. Only four injectors are shown in this generic diagram for clarity, and the Plus 8 has an additional filter between the pump and the fuel rail.

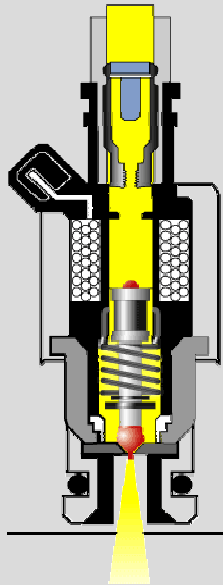
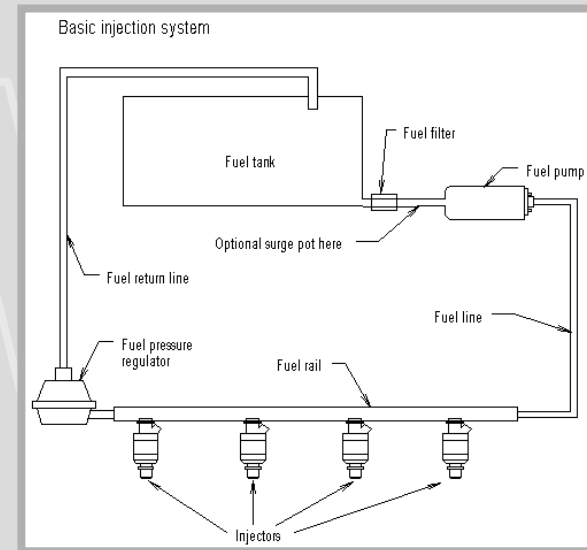

- The fuel injector is an electrically-controlled solenoid that allows pulses of fuel to be injected into the inlet ports. The amount of fuel injected is varied by changing the time the injector is open by means of the injector pulse width. There is one injector for each cylinder, and the fuel is kept at a constant pressure differential between the fuel rail and the inlet by the fuel pressure regulator, fitted at the rear of the fuel rail on the left of the engine.



# Fuel and Ignition Control

- Most Fuel Injection (FI) systems use a mass air flow sensor of some type – early ones derived the MAF from the manifold depression, but later systems measured it directly by means of a flapper valve or, in GEMS, by the change in resistance with mass air flow of a hot wire. Some early systems use a standard distributor to control ignition, but more advanced systems such as GEMS compute both fuel and ignition parameters. It might be assumed that each fuel pulse would only vary with the quantity of air ingested each stroke, which is measured by MAF. In fact, the efficiency of the intake system varies with RPM and throttle opening as it is affected by internal resonances. The FI systems store this information in an n-dimensional Fuel Map, and use this data to compute the length of the injector pulse. This is sent to the injector in the form of an electrical pulse of variable width, using a technique called Pulse Width Modulation (PWM). The later systems use a crankshaft position sensor on the flywheel to determine firing and injection firing position, and a camshaft position sensor to make sure that they occur on the correct stroke.
- The later systems also use Direct Ignition, with a single or double-ended coil connected to each cylinder or pair of cylinders. The ignition advance is computed using a similar map to the fuel system.

# Fuel and Ignition Maps

- This is a typical Fuel Map – it applies corrections to the measured mass air flow (or the air flow implied by the manifold pressure in this example) caused by variations in the pumping efficiency of the engine as the RPM changes. A similar three-dimensional map is used to calculate ignition advance at various RPM and load values.
- GEMS uses engine speed and Mass Air Flow instead of Manifold Pressure as inputs, and the final output is injector pulse width.

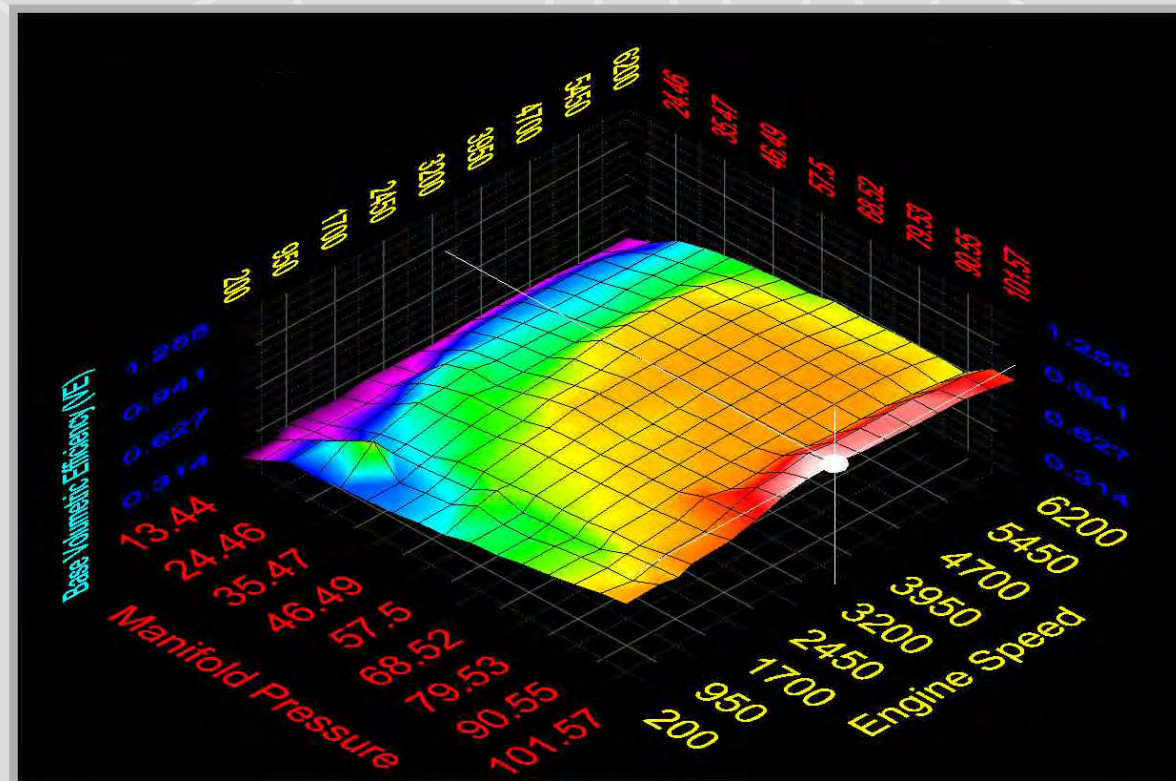

# GEMS

## Introduction to GEMS

# Introduction to GEMS - 1

- GEMS is an advanced digital closed-loop Sequential Fuel Injection (SFI) system with Direct Ignition (DI), controlled by an Intel digital processor in the Engine Control Module (ECM), which together with the sensors and IACV actuator forms the Engine Management System (EMS). It uses the ISO 9141-2 interface standard (which in the US is referred to as Chrysler/Import), and is in full conformance with NAS OBD-II standards.
- It can adapt to minor changes in engine characteristics, and can control the ignition advance of each cylinder independently if knock is detected. There are no external user adjustments except for the idle air bleed bypass, which is under a blanking plug on the throttle body. It is fitted to the Plus 8 in the North American Specification (NAS) standard, with four O<sub>2</sub> (Lambda) sensors, one in front and behind each catalytic converter.
- GEMS stores all the operational parameters including fuel and ignition maps in two PROMS, which can be removed or changed when the ECM is opened. It also stores adaptive and setup data (such as Manual/Auto transmission, Engine capacity and VIN) in Erasable PROMS so that the main settings are not lost if the power to the ECM is interrupted.

# Introduction to GEMS - 2

- It uses a high pressure fuel rail maintained at a constant pressure differential (35 psi) with respect to the inlet manifold, and the injectors are timed to fire on each intake stroke. The mixture is controlled by measuring the mass air flow into the engine, applying corrections for temperature and variations in engine intake efficiency with RPM, and then calculating the correct injector pulse width needed to achieve the desired fuel/air ratio. The oxygen content of the resultant exhaust gas is measured and corrections made to the injector pulse width – these take the form of long and short term fuel trims. The short term fuel trim varies in real time as the engine changes operating conditions, but the long term fuel trim is calculated as an average of the short term fuel trim value and changes very slowly. The long term fuel trim is one of the adaptive parameters and is stored when the engine is shut down.
- The idle speed is controlled by the Idle Air Control Valve (IACV), which uses a stepper motor to open and close the idle air bleed. There is also an air bleed bypass which must be set to ensure that the IACV operates in the correct part of its range – a dirty IACV or incorrect setting of this bypass are the most common problems when idle faults are encountered. GEMS determines that the throttle is closed by comparing the voltage from the throttle position sensor with a stored value of the closed position, so if the stored value is incorrect GEMS will not be able to detect closed throttle or idle correctly.

# Operational Modes

- GEMS normally operates in a closed loop mode, using the data from the heated O2S to optimize the fuel/air mixture
- Under some conditions GEMS will default to open loop control; the full list of operating modes is shown below. These can only be read by a Rovacom or similar diagnostic unit.
  - OPEN NOT YET SATISFIED CONDITIONS
    - The engine is not running or is still too cold to use the feedback from the sensors so when there is nothing wrong, the system is open loop
  - CLOSED USING O2 SENSORS NORMALLY
    - This is the usual operating mode; the engine is operating normally with no faults detected
  - OPEN DUE TO DRIVING CONDITIONS
    - The system has been using the sensors and there are no problems, but it has decided not to use them at the moment, as the feedback is not required for correction
  - OPEN DUE TO A DETECTED FAULT
    - There is a fault with the sensor and the system has reverted to using the pure map without the aid of closed loop correction
  - CLOSED BUT AN O2 SENSOR IS FAULTY
    - This can only happen in vehicles fitted with two sensors per bank, or the NAS standard. This applies to all Plus 8 manufactured with the Advanced Evaps system. Although the system knows one of the sensors is faulty it can switch to using the other one to give closed loop fuel correction

# Adaptive Parameters - 1

- The adaptive parameters use a Z-transformed statistical technique to calculate the average difference between the mapped settings in the ECM EPROMS and the actual settings required due to minor difference in the engine build standard. Since they compute an average over time the car will have to be driven for some distance before they converge to the correct values.
- The main adaptive parameters are:
  - Adaptive Fuel Mass Flow Rate
    - The Adaptive Fuel Mass Flow Rate (FMFR) is learnt by the system over a period of time and is added to the normal fuel rate to compensate for manufacturing tolerances between fuelling components
    - The limits are + 0.625 to -0.625, after which it will log a fault in its memory
  - Adaptive Air Mass Flow Rate
    - The Adaptive Air Mass Flow Rate (AMFR) is learnt by the system over a period of time and is added to the normal air rate to compensate for manufacturing tolerances between airflow components
    - The limits are + 5.5 Kg/hr to -5.5 Kg/hr after which it will log a fault in memory
  - Short Term Idle
    - This is the value that the GEMS uses to regulate the current idle speed to take into account current engine load, temperature, etc
  - Long Term Idle
    - This is the value that the GEMS learns over a period of time to take into account manufacturers tolerances on component which affect overall idle speed

# Adaptive Parameters - 2

## ■ Closed Throttle Value

- This Adaptive value is stored by the GEMS so it knows when the engine is at idle
- If any adjustments are made which result in the stored value being lower than the current throttle position with the throttle properly closed poor idle characteristics may occur
- Gems can re-learn its new value by re-setting all ECM Adaptations when it will be set to 0.85 volts – the first time the engine is started the ECM will then store the new closed throttle value. It can also be set manually, but this is not advised.
- There are number of other parameters that will be affected by the reset function, including the Long Term Fuel Trim, but these are of lesser importance and rapidly adapt after a reset operation.



# GEMS

## General Considerations

# General Considerations - 1

- GEMS in the Morgan Plus 8 is a well engineered system that was fitted to a variety of Land Rover (LR) vehicles, but the most easily accessible manuals are those of the Discovery 1 of 1998, just before LR changed to the Bosch Motronic. There are very few LR factory recalls or bulletins, and it is probable that any reliability or performance problems are due to lack of, or poor, maintenance. The system has default strategies for all sensors except two – Mass Air Flow and Crankshaft Position Sensors. Failure of either of these, or the fuel pump, will stop the engine.
- GEMS can easily be maintained by the average home mechanic, but a diagnostic computer is essential. There are many generic OBD-II system available from around \$150 and they are useful for emission compliance information as well as general fault diagnosis. Autotap (<http://www.autotap.com/>) is installed on a laptop and has real time data logging capabilities, and was used in the development of this presentation.
- In addition, a special purpose GEMS diagnostic unit is essential for the long-term maintenance of the system. It is required to read the GEMS-specific data not available through a generic OBD system, to reset the adaptive parameters, set the idle performance, and for all security system settings. There are only three manufacturers of these; TestBook is only available to official LR dealers, while Autologic and Rovacom were developed for sale to independent garages.

# General Considerations - 2

- The cheapest of the GEMS-specific systems used to cost in excess of \$10,000, and so service of any GEMS system was impossible for the average owner until BlackBox released the RovacomLite (<http://www.rovacomlite.com/>) in 2003. With the GEMS and Lucas 10AS modules it costs around \$1000, and was also used in the development of this presentation.
- Performance PROMS are available from RPi (<http://www.rpiv8.com/>) and result in a significant improvement in engine response and performance. You will need to fit knock sensors if they are not already fitted.
- If it is necessary to open the ECM or change sensors take anti-static precautions to avoid damaging the ECM or PROMS, and use surgical rubber gloves. Be careful not to contaminate connector pins - perspiration or contamination will corrode them over time. You do not need to disconnect the battery when you remove the ECM, although it cannot hurt. If you do disconnect the battery GEMS will have to re-learn some adaptive settings which may take up to 50 miles or so.
- GEMS has settings for both manual and automatic transmissions, and 4.0 and 4.6 liter engines. The automatic transmission setting can cause a reluctance for the engine to decelerate, and the wrong capacity engine setting can cause incorrect mixture at higher RPM. The settings can only be checked or changed with one of the special GEMS diagnostic systems.

# GEMS

## Tools and Precautions

# Tools and Precautions

## ■ Tools:

- The usual mix of AF and Metric wrenches and a torque wrench to fit knock sensors.
- A TORX 25 driver to open the ECM.
- An Electro-static discharge wrist strap, pad, and chip puller when changing PROMS.
- An OBD II diagnostic system for Chrysler/Imports (to check and clear DTCs, reset the MIL indicator, to access freeze-frame data, and emission-related OBDMs).
- A Rovacom Lite diagnostic unit with a GEMS module (to check and clear DTCs, reset the MIL indicator, access GEMS-specific data, and reset the adaptive data); and a 10AS module to interface with and set up the alarm system.
- A Volt-Ohm Meter (VOM)
- A Fuel Injection Fuel Pressure Gauge.

## ■ Precautions.

- Depressurize fuel system before changing injectors or other work on the high pressure system (the easiest way it to use the fuel pressure tester to depressurize it).
- Clean the outside of all connectors before disconnecting (glass cleaner if nothing else is available), and protect the pins and inside of the connectors after disconnection (plastic bag and rubber band).
- Use ESD precautions when opening the ECM – although it is very rugged it is an expensive unit.
- Do not change the PROM chips unless you have access to a TestBook or Rovacom diagnostic unit – the car will not start unless you make GEMS re-learn security.

# GEMS

## Morgan-Specific Differences

# Morgan-Specific Differences - 1

- There are a number of differences in the Morgan Plus 8 GEMS installation as compared to the standard Land Rover application from which it was derived, and these are listed below.
- Low Fuel Sensor
  - There is a “low fuel” sensor line which stops the ECM adapting if the fuel supply is interrupted when the tank is almost empty. It also prevents the ECM registering misfires from low fuel as trouble codes. Morgan use a “Fuel Level ECU” behind the dashboard to provide the correct voltage to the fuel gauge and the ECM – but some cars appear not to have this line connected. The fuel level input line should be held low (0 volts) to allow the ECM to adapt.
- Automatic Transmission Inputs
  - The EMC has a “transmission retard” input from the automatic gearbox which is used to reduce power and so enable smoother shifts with the automatic transmission. Neither this or any other of the auto box inputs that could affect the ECM operation are enabled.
- Rough Road Input
  - In Land Rover applications random variations in wheel speed are detected by the Antilock Brake System to set a “rough road” input to the ECM, which then uses this information to disable the misfire error codes that would otherwise be set due to the sympathetic variations in crankshaft RPM.
  - Since ABS is not fitted to the Plus 8 this means that there is the possibility that the misfire monitor and “check engine” light may be set if large throttle openings are used on really rough roads

# Morgan Specific Differences - 2

## ■ OBD Diagnostic Interface

- Pin 5 should be connected to Signal Ground to conform to the ISO 9141-2 standards, and the lack of this connection will cause the car to fail the emission control test. A new pin or connector will have to be obtained, and pin 5 can be connected to ground to comply with the requirement.

## ■ Other EMC Interfaces

- Other interfaces that are not used include a fuel totalizer output; a heated windscreen and air conditioning in-use inputs; engine torque output, engine speed out and throttle angle signal output to the transmission; ignition retard signal (to reduce power and ease gear shifts) from the transmission; and an air conditioning condenser fan actuation output. The GEMS engine speed output is not used and the tachometer uses the alternator frequency as the source of engine RPM.
- Since the ECM does not control the radiator fan – even though it could - this is controlled directly by the thermostatic switch in the base of the radiator through a relay on the right front side of the bulkhead.

## ■ Knock Sensors

- The knock sensors were removed from the Plus 8 at the same time that the “advanced evaps” system was installed.
- The interface connectors and harness are fastened to the main harness across the front of the engine and on to the starter motor cable on the lower right hand side.
- If performance PROM chips are to be fitted two LR knock sensors will be required if they are not fitted. They are available from LR - part number ERR5594, and generally available next day from LR dealers. Two small heat shields are also required, and are available from MMC. The heat shields are designed to be bolted to the engine mountings, and suitable holes will have to be drilled in the engine mounts and the heat shields. It is important that the sensors are tightened to the correct torque – 12 lbs/ft.



# GEMS

## Known Failures

# Known Failures - 1

- As far as is known there are three types of failures that have been experienced on Morgans, but they may be isolated instances and not cause for concern. They are mentioned as general background material in case similar symptoms are experienced. The only Technical Bulletin issued by LR is for CKP/Flywheel contact which is the first of the failures mentioned below.
- Crankshaft Position Sensor/Flywheel Contact
  - Symptoms - the engine momentary cuts out or misfires especially when the clutch is pressed in. If the CKP sensor is removed it will show a bright spot where contact has occurred.
  - Cause – momentary contact between the tip of the CKP and the flywheel reluctor rings caused by either a loose CKP housing (it is bonded into the crankcase) or incorrect clearance being set during engine manufacture
  - Solution – remove the inspection panel under the bell-housing and the CKP sensor, and check for signs of contact on the sensor and on the reluctor rings. Check the CKP Sensor housing and ensure that it is firmly bonded to the crankcase. If it is loose, remove it, clean the two surfaces and re-bond it using a reliable two-part epoxy. Replace the CKP sensor and set the sensor housing so that the sensor sits between the two rows of reluctor ring and enters them to a depth of 0.020. If the housing is securely bonded the problem is due to incorrect housing placement during manufacture, and the solution will depend on the extent of the misalignment problem. It may be possible to remove the housing, but if it is securely bonded it this may prove to be a difficult task. In this case the sensor can be re-positioned using shims, or in an emergency the tip of the sensor can be filed to avoid contact.
  - CAUTION - When re-installing the sensor make sure that the tip is not contaminated by magnetic debris, which can also cause problems.
  - CAUTION – The sensor is supplied with an alloy spacer. Some engines have this spacer bonded to the housing, and care should be taken to make sure that two spacers are not inadvertently fitted.

# Known Failures - 2

## ■ IACV Contamination

- Symptoms - the symptoms are an unstable idle or failure of the engine to idle at all.
- Cause – if the car is not used regularly there have been instances of the IACV becoming contaminated with either corrosion or dirt.
- Solution – remove the IACV and clean the pintle valve and throttle body housing with carburetor cleaner. After re-assembly the Idle Setup Procedure should be carried out.
- CAUTION - take care not to force the stepper motor controlling the pintle valve to change position
- NOTE –similar symptoms can be caused by mis-adjustment of the bleed air bypass valve. If the symptoms persist after cleaning the valve and the Idle Setup Procedure has not been performed it is almost certain that this is the cause.

# Known Failures - 3

## ■ Fuel Pump Partial or Complete Failure

- Symptoms (1) – Check engine light (MIL) during normal operation, accompanied by DTC P1176 - Maximum Positive FMFR Correction Fault.
- Symptoms (2) – Intermittent or Complete failure of the fuel pump
- Cause (1) – the fuel pump has a canister around it with a foot valve that is designed to retain fuel around the pump when fuel is low. Excessive silicon sealer used around the fuel pump body/O-ring interface can be being extruded and fall into the tank where it is sucked into the valve, holding it open and preventing free flow of fuel into the pump. This can have two effects (1) the fuel pump output is reduced causing the ECM to attempt correction, and the subsequent setting of the MIL light and P1176 or (2) overheating of the fuel pump and partial or complete failure.
- Cause (2) – the fuel pump connector can be contaminated with underseal during car manufacture. The connector may then have a high resistance contact which can lead to partial or complete fuel pump failure.
- Solution – replace the fuel pump, and cut off and replace the connector on the wiring harness if it shows signs of overheating.
- In order to replace the pump the battery should be disconnected and the spare wheel, mounting bracket and trim plate should be removed. The fuel should be siphoned out of the tank after removing the hose to the fuel filler. The fuel system should be de-pressurized and the fuel pipe connectors removed by pressing the locking tabs, and the pipes should be labeled to avoid mixing them up. The fuel pump can be removed after removing the tank securing bolts and then undoing the fuel pump retaining bolts, when the tank can be maneuvered to allow room for the pump to be removed. A short fuel pump interface wiring harness is available from LR and should be spliced into the Morgan harness with crimped splices and heat shrink tubing. Assembly is the reverse of the above procedure.

# GEMS

## **GEMS Diagnostic Tools**

# GEMS Diagnostic Tools

- There are two main diagnostic tools required to maintain the GEMS system. LR Dealers use TestBook or Autologic, but these cost over \$10,000. Rovacom Lite has the same functionality and costs around \$1000, but you will need a laptop to host it. A typical OBD diagnostic system will cost between \$50 - \$350.
- The data that can be accessed are:
  - Rovacom (TestBook or Autologic)
    - DTCs and MIL reset
    - GEMS-specific and other data
    - Adaptive Reset
    - Idle Setup
    - Security Learn procedures
    - Output commands (fuel pump is the only significant item)

*Rovacom does not allow access to OBD monitors or freeze-frame data*
  - Generic OBD-II Diagnostic System (AutoTap, Actron, etc)
    - DTCs and MIL reset
    - Standard OBD mandated data and freeze-frame data
    - OBD monitors

*Generic OBD tools do not allow access to GEMS-specific data, reset or security command options*

# OBD-II Interface Connector

- The OBD connector is under the dashboard on the passenger side of the car, and conforms to the ISO 9141-2 Standard (Chrysler/Import). It uses the pin designations shown below, which are shown as viewed from the front of the connector.
- Pin 5 is not populated in the Plus 8, but it is required to pass the standard post-1995 emissions control test in the US. A new pin should be obtained and connected to chassis ground. Pin 8 is connected to the Lucas 10AS system.

- Pin 4           Chassis Ground
- Pin 5           Signal Ground
- Pin 7           ISO 9141 K line
- Pin 8           Manufacture's Discretionary (Rover)
- Pin 15          ISO 9141 L Line
- Pin 16          Unswitched battery positive

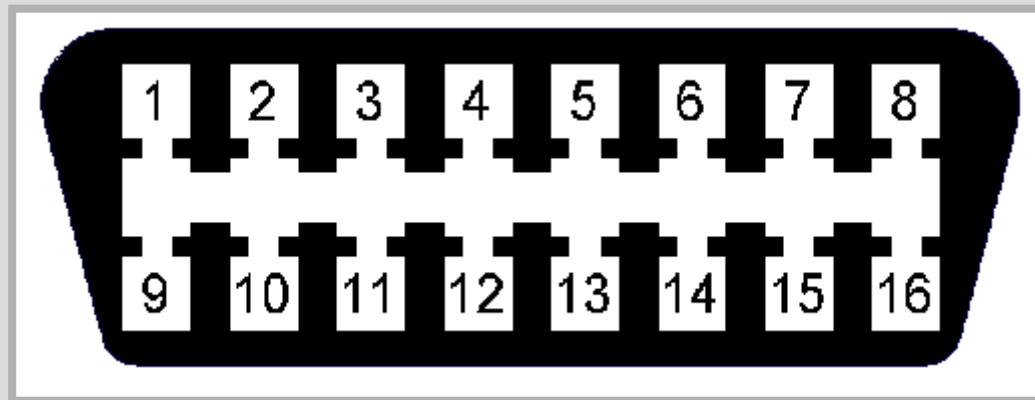

# GEMS Data

- There are different categories of data available from GEMS that can be read through the OBD interface, and there are also some data that can be sent to GEMS, including a reset to initialize the adaptive data, and commands to operate various control functions such as the fuel pump.
- The data and resets available to both generic OBD and Rovacom diagnostic units are:
  - Generic data which includes general operational parameters such as vehicle speed, ignition advance, engine speed, oxygen sensor output, water temperature, etc.
  - Trouble Codes (generic and enhanced)
- The data available to only an OBD diagnostic unit is:
  - The OBD monitors (OBDM) which monitor critical emission-specific subsystems and parameters, and which must be set in order to pass the emissions inspection.
- The data and resets available to only the Rovacom diagnostic units are:
  - The GEMS specific data, such as adaptive settings, idle data and security settings
  - All other system setup, reset, and command functions



# Reading DTCs

- The OBD standard provides for a number of Diagnostic Trouble Codes (DTC) that are used to identify failures in the operation of the ECM. The DTCs fall into two main categories – generic codes and manufacturer-enhanced codes. Generic OBD diagnostic computers will identify both the numeric identifier and descriptive text string for the generic codes, but will usually only show the numeric identifier for the manufacturer-enhanced codes.
- The Diagnostic Trouble Codes (DTCs) have a character followed by four digits: the first character in the DTCs refers to the major related system; P stands for Powertrain and is the only one supported by GEMS.
- The second character is a zero for a generic code or a “1” if it is a manufacturer enhanced code (specific to the GEMS systems).
- The third character in the code identifies the system where the fault occurred
  - 1 and 2 are for fuel or air metering problems
  - 3 is for ignition problems or engine misfire
  - 4 is for auxiliary emission controls
  - 5 relates to idle speed control problems
  - 6 is for computer or output circuit faults
  - 7 and 8 relate to transmission problems
- A P0300 code (for instance) would indicate a random misfire. If the last digit is a number other than zero, it corresponds to the cylinder number that is misfiring. A P0302 code, for example, would indicate that cylinder number two is misfiring

# OBD-II Data

- The following generic OBD data are available from the ECM through any OBD diagnostic system
  - Calculated Engine Load
  - Engine Coolant Temperature
  - Engine Speed
  - Fuel System Status Bank 1
  - Ignition Timing Advance
  - Intake Air Temperature
  - Long Term Fuel Trim Bank 1
  - Long Term Fuel Trim Bank 2
  - Mass Air Flow Rate
  - O2 Sensor Bank 1 Sensor 1
  - O2 Sensor Bank 1 Sensor 2
  - O2 Sensor Bank 2 Sensor 1
  - O2 Sensor Bank 2 Sensor 2
  - Short Term Fuel Trim Bank 1
  - Short Term Fuel Trim Bank 2
  - Short Term Fuel Trim from O2 Sensor Bank 1 Sensor 1
  - Short Term Fuel Trim from O2 Sensor Bank 1 Sensor 2
  - Short Term Fuel Trim from O2 Sensor Bank 2 Sensor 1
  - Short Term Fuel Trim from O2 Sensor Bank 2 Sensor 2
  - Throttle Position Angle
  - Vehicle Speed

GEMS

# OBD Monitors

- The OBD system uses a number of monitors (OBDM) to assure that the vehicle emissions are within design limits. These monitors are actually computer flags that are set when the output from the monitor algorithm (each of which has a number of inputs) falls between two values.
- There both continuous and non-continuous monitors – but in order to set them all the vehicle must be driven through a complete drive cycle
- The emissions tests (in the USA) for post '95 vehicles do not use an exhaust analysis/rolling road test but instead read the OBDM through the diagnostic interface. A maximum of one OBDM can be in the “Incomplete” or “Fail” state if the vehicle is to pass..
- The monitors used in the Plus 8 (with the MMC chips) are:
  - Catalyst Monitor Status
  - Comprehensive Component Monitoring Status
  - Evaporative System Monitor Status
  - Fuel System Monitor Status
  - Misfire Monitor Status
  - O2 Sensor Heater Monitor Status
  - O2 Sensor Monitor Status
  - OBD Requirements - CARB

# Drive Cycle

- The monitors will be set to “Incomplete” when either there is a failure in the ECM that will cause the emission limits to be exceeded, or when the DTC’s are cleared.
- In order to set all the monitors the Plus 8 should be driven through at least one complete Drive Cycle, as shown
  - Switch on ignition for 30 seconds.
  - Ensure that coolant temperature is less than 30 °C (86 °F)
  - Start engine and allow to idle for 2 minutes.
  - Perform 2 light accelerations 0 to 35 mph (0 to 56 km/h) with light pedal pressure
  - Perform 2 medium accelerations 0 to 45 mph (0 to 72 km/h) with moderate pedal pressure
  - Perform 2 hard accelerations 0 to 55 mph (0 to 88 km/h) with heavy pedal pressure
  - Cruise at 60 mph (96 km/h) for 5 minutes
  - Cruise at 50 mph (80 km/h) for 5 minutes
  - Cruise at 35 mph (56 km/h) for 5 minutes
  - Allow engine to idle for 2 minutes
- Connect OBD-II Diagnostic interface and check that all OBDM are set

# GEMS

## Engine Control Module

# Engine Control Module

- The ECM is located in front of the bulkhead on the passenger side, under a sloping stainless steel housing. The ECM can be removed by using the following procedure. It is not necessary to disconnect the battery before removing the ECM.
  - Cover the wing with a soft cloth to protect it in case the ECM is accidentally dropped.
  - Lift the rubber flap and disconnect the three connectors. They have a retaining tab that is released by pressing the plastic bar at the center of the connector – the two black connectors have this bar at the top and the red one has it at the bottom.
  - Wearing protective gloves, remove the four screws that retain the stainless steel housing and remove it from the car. The housing has extremely sharp edges and it is very easy to cut yourself on it.
  - With the housing the on the workbench remove the two screws retaining the ECM and slide it out.
  - Installation is the reverse of the above procedure.

# ECM Interfaces

- The ECM has three connectors; C509, C507, and C505 as shown. C507 is red and the other two are black.

GEMS

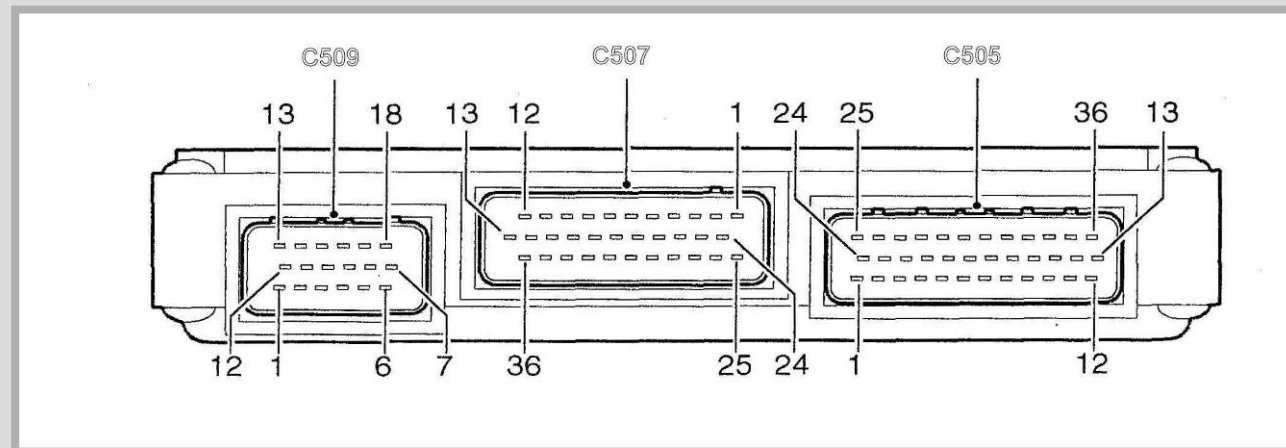

# C509 Pin Designations

Pin No.	Description	Input/Output	Voltage
1	Coil driver - Cylinders 5 & 8	Output	0 - 12V
2	Not used		
3	Not used		
4	Throttle Position Sensor	Output	5V supply
5	ECM to chassis ground	Ground	0V
6	Not used		
7	Main relay supply	Input	0 - 12V
8	Ignition sense	Input	0 - 12V
9	ECM to chassis ground	Ground	0V
10	ECM to chassis ground	Ground	0V
11	Crankshaft(CKP)sensor-ve	Ground	0V
12	Crankshaft (CKP) sensor +ve	Analogue input	18V (average) at 480Hz
13	Coil driver - Cylinders 2 & 3	Output	0 - 12V
14	Coil driver - Cylinders 1 & 6	Output	0 - 12V
15	Coil driver - Cylinders 4 & 7	Output	0 - 12V
16	ECM to chassis ground	Ground	0V
17	Main relay control	Output	Switched to ground
18	Not used		



# C507 Pin Designations

Pin No.	Description	Input/Output	Voltage
1	Rough road detected	Input	0 -12V
2	Camshaft position (CMP) sensor	Input (2 pulses per engine revolution)	12V (average)
3	Not used		
4	Transfer box (Low range detected)	Input	0 - 12V
5	Not used		
6	Not used		
7	Fuel level	Input (out of range and validity check only)	0 - 12V
8	HO2S Bank B Upstream	Input	0V (Rich) - 5V (Lean)
9	Not used		
10	Knock sensor ground	Ground	0V
11	Knock sensor A	Input	Voltage signal proportional to level of knock detected
12	Knock sensor B	Input	Voltage signal proportional to level of knock detected
13	Air temperature sensor	Input	1 k-ohm to 1.3 k-ohm at 40°C (140°F)
14	Coolant temperature sensor	Input	4.7V at -30°C (-22°F) to 0.25V at 130°C (266°F); 2.0V at 40°C (104°F)
15	Throttle position sensor	Input	0 to 5V (0.6V at idle; 4.5V typical max.)
16	Mass air flow (MAF) Sensor	Analogue input	0 to 5V (1 .4V at idle)
17	HO2S sensor Bank A downstream	Input	0V (Rich) - 5V (Lean)
18	Park/Neutral Switch	Input	0V (Park/Neutral) - 12V (Drive)
19	Not used		
20	Diagnostic 'L' Line	Bi-directional	Serial 0 - 12V
21	Heated front windshield	Output	0V or 12V
22	Not used		
23	Diagnostic 'K' Line	Bi-directional	Serial 0 - 12V
24	Not used		
25	Not used		
26	Immobilization	Input	Serial 0 - 12V (366 baud)
27	Vehicle speed	Input	PWM 0 - 12V (8000 pulses / mile)
28	A/C request	Output	0V or 12V
29	Condenser cooling fan request	Input	0V or 1 2V
30	Fuel Pressure Sensor (from 97.5 MY)	Input	1 k-ohm to 1.3 k-ohm at 40°C (140°F)
31	Ignition Retard Request (EAT ECU)	Input	12V PWM
32	HO2S sensor	Ground	0V
33	HO2S sensor Bank B Downstream	Input	0V (Rich) - 5V (Lean)
34	HO2S sensor Bank A Upstream	Input	0V (Rich) - 5V (Lean)
35	Fuel temperature sensor	Input	1 k-ohm to 1.3 k-ohm at 40°C (140°F)
36	Sensor ground	Ground	0V

# C505 Pin Designations

Pin No.	Description	Input/Output	Voltage
1	A/C grant	Output	0V or 12V
2	Fuel used	Output	Serial 0 - 12V (12000 pulses per liter)
3	Condenser cooling fan	Output drive	Switch to ground
4	Not used		
5	Not used		
6	Canister vent solenoid (from 97.5 MY)	Output	0 - 1 2V
7	Not used		
8	Not used		
9	Not used		
10	Not used		
11	Injector - Cylinder 3	Output	0 - 12V
12	Not used		
13	Injector- Cylinder 1	Output	0- 12V
14	Not used		
15	IACV-D Stepper motor	Output	Stepped by sequentially changing voltage polarity
16	IACV-B Stepper motor	Output	Stepped by sequentially changing voltage polarity
17	Injector - Cylinder 6	Output	0 - 12V
18	Injector - Cylinder 8	Output	0 - 12V
19	Purge valve	Output	0 - 12V (100 Hz)
20	Not used		
21	HO2S sensor Upstream - Heater supply	Output	Heater resistance is 5.7 ohms
22	Malfunction Indicator Lamp (MIL)	Output drive	Switch to ground
23	Engine speed output	Output	12V square wave (4 pulses per revolution)
24	Fuel pump relay	Output drive	Switch to ground
25	Not used		
26	Not used		
27	Throttle position	Analogue input	0 - 5V (1 .4V at idle)
28	HO2S sensor Upstream - Heater supply	Output	Heater resistance is 5.7 ohms
29	Engine torque	Output	12V PWM
30	Injector - Cylinder 4	Output	0 - 12V
31	Not used		
32	Injector - Cylinder 7	Output	0 - 12V
33	Injector - Cylinder 5	Output	0 - 12V
34	IACV-C Stepper motor	Output	Stepped by sequentially changing signal polarity
35	IACV-A Stepper motor	Output	Stepped by sequentially changing signal polarity
36	Injector - Cylinder 2	Output	0 - 12V

# ECM Top Cover

- The ECM top cover is the one on top when the red connector is uppermost.
- The ECM must be dismantled in this order – the lower cover and PC board has heat sink retaining clips that can only be accessed after the top board has been removed. On some ECMs the middle screw on the left had side is pressurized with a small amount of gas to detect tampering, and will hiss when removed. This has no effect on operation.



# ECM MMC PROMS

- These 9664 PROMS are fitted to 2002 cars
- 9660 PROMS are fitted to 2000 cars

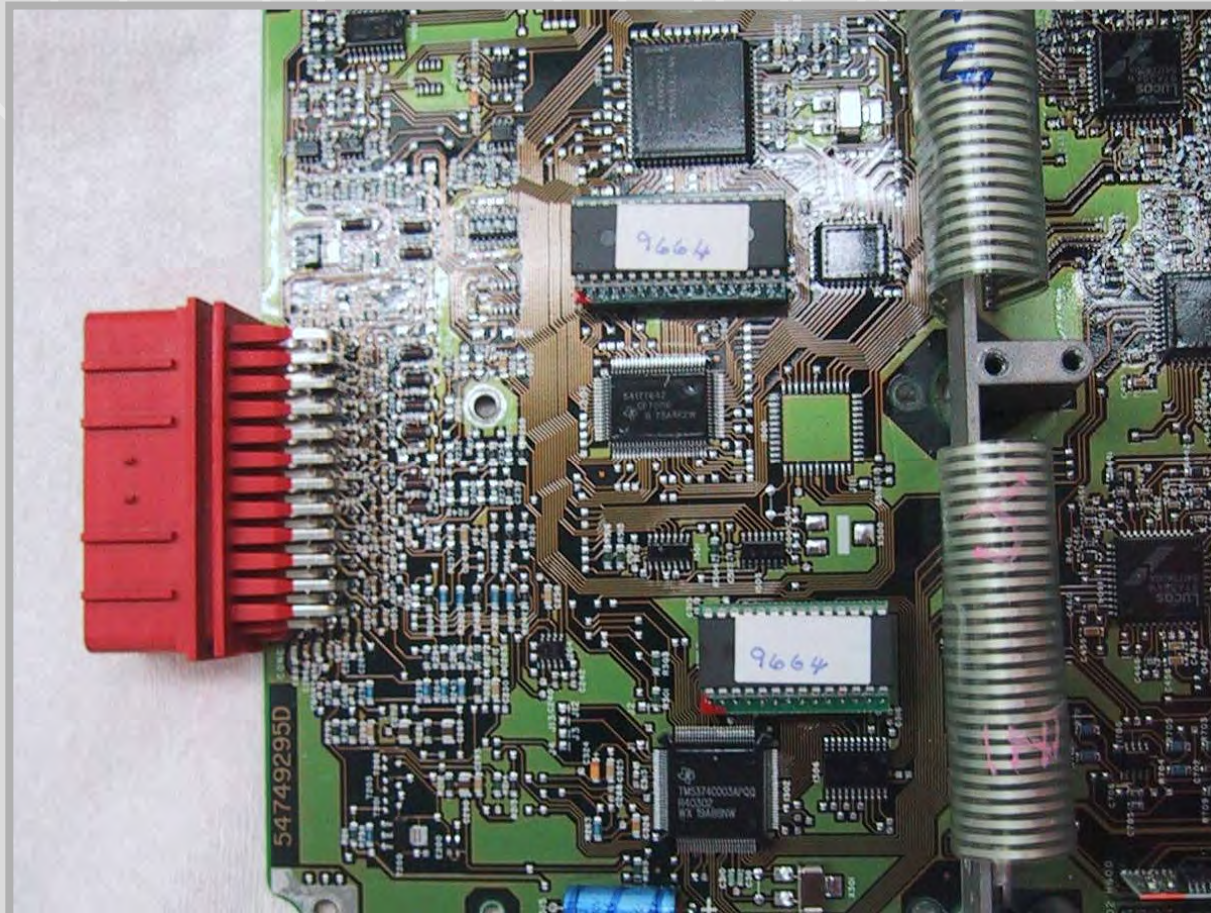

# ECM T9619 PROMS

- The main aftermarket PROM supplier is RPi, who supply Tornado chips
- The smaller PROM is the DSP and is not changed as the version changes
- The larger PROM is an experimental version for US certification

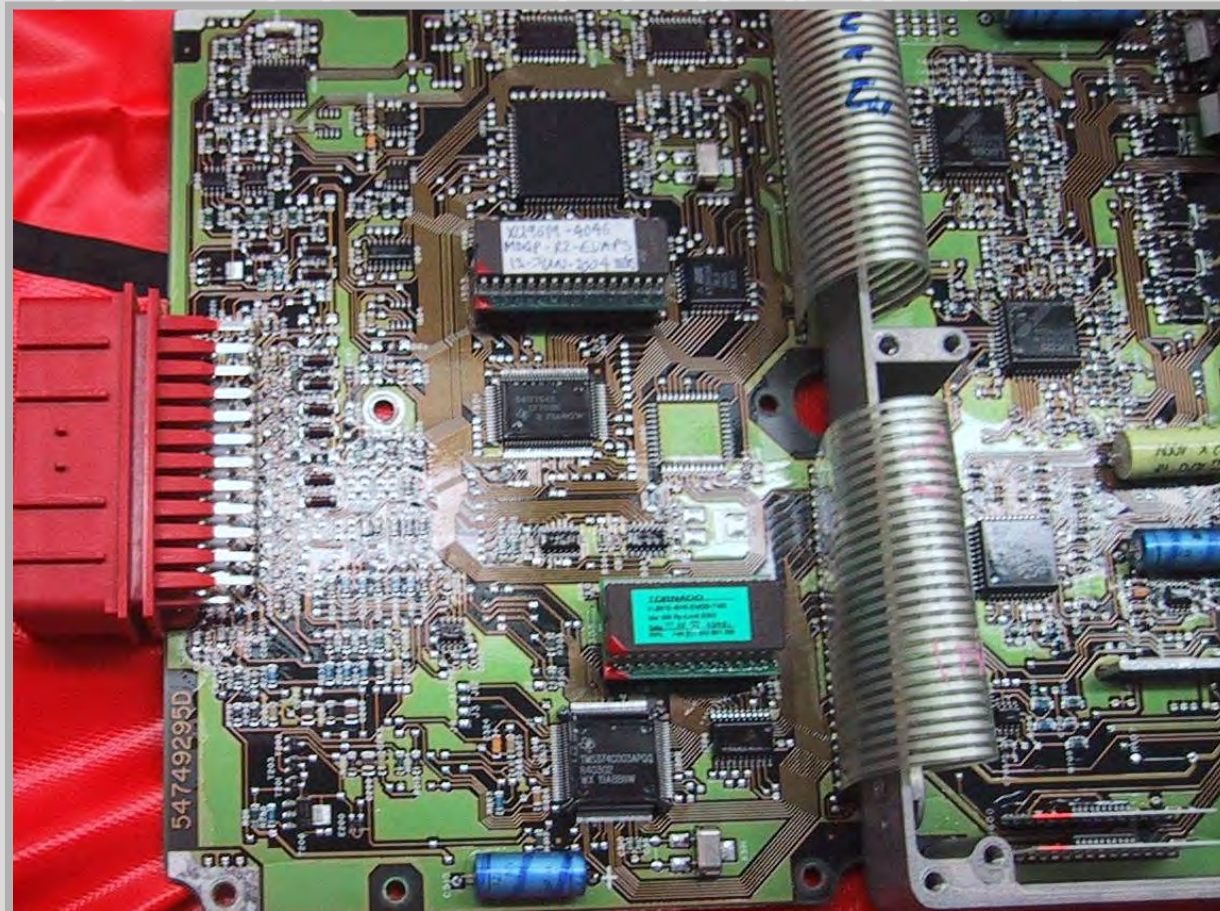

# GEMS

## EMS Components

# EMS Components

- There are a number of sensors, actuators, relays, injectors, ignition components and relays associated with the GEMS systems. These, together with the ECM form the Engine Management System.
- Most components can be obtained from LR dealers, or British Atlantic in the USA and specialist LR suppliers in UK and Europe.
- The system appears to be derived from the NAS specification 1998 Defender, but with a manual transmission fitted. The 1998 Discovery I is also very similar.

# Crankshaft Position Sensor

- There are a total of 14 sensors, including two Knock Sensors and four HO2S probes. The sensors are listed below;
- Crankshaft Position Sensor (CKP)
  - Part Number: ERR6357
  - Heat shield: ERR6573
  - Located on the left bell-housing, and excited by the reluctor ring on the flywheel which has 35 teeth and one space positioned at 20deg after TDC.
  - There is no default strategy, so the engine will stop if it fails. There have been instances of the clearance being too small and the crankshaft moving forward and contacting the sensor when the clutch is pressed causing the engine to cut out.

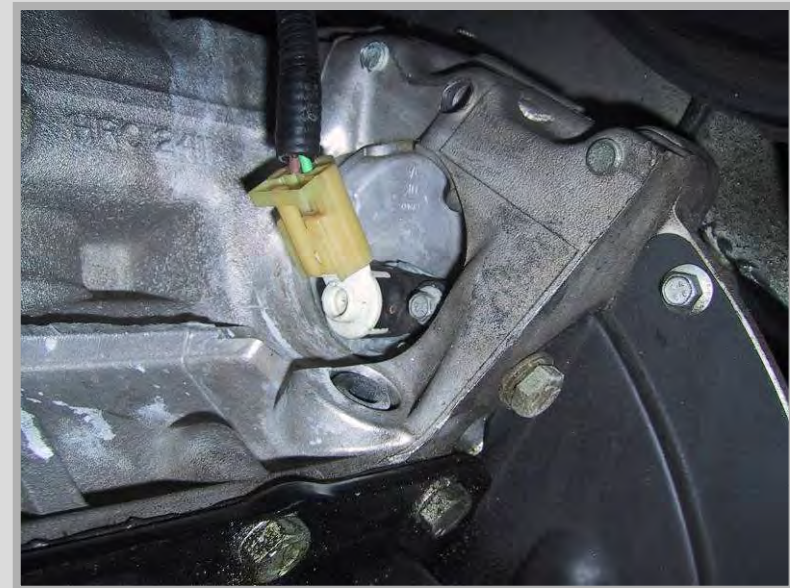
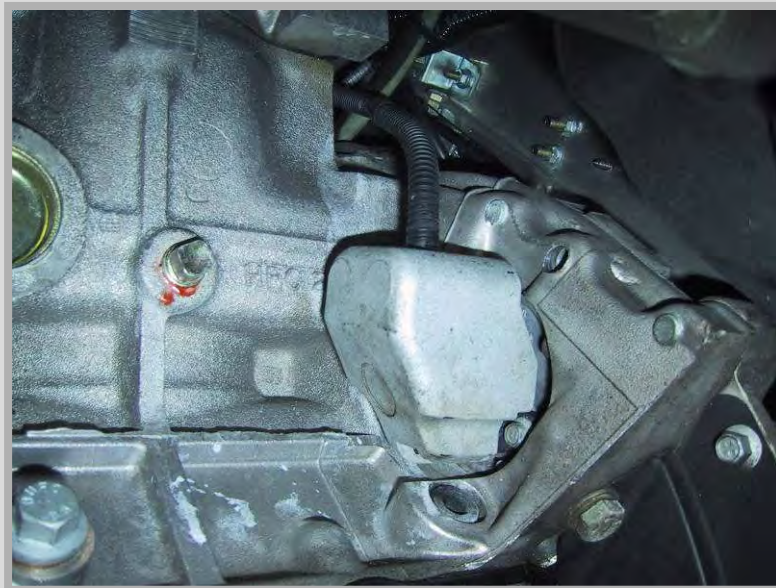



# Camshaft Position Sensor

- Camshaft Position Sensor (CMP)

- Part Number: ERR6169

- Bracket: ERR7170

- O-Ring: ERR4815

- This sensor is located on the engine front cover. It produces four pulses (three long and one short) every revolution of the cam, or every two revolutions of the engine (to identify the firing stroke). If you change the cam you have to make sure that you use a GEMS gear and not one from an earlier or later engine. It is also the reason that you cannot change to a two-row timing chain on this engine.

- In the event of failure the default strategy is to continue normal operation, but the injection may be one revolution out of synchronization. This is “not easily detected by the driver” to quote one source. The ignition will operate as normal since GEMS produces a spark on both exhaust and compression strokes.

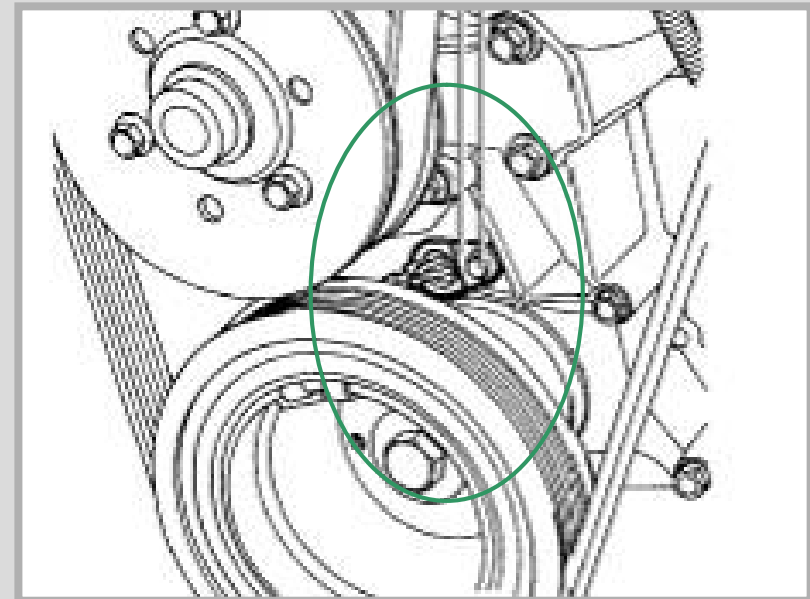

# Canister Purge Valve

## ■ EVAP Canister Purge Valve (CPV)

- This is located on the right bulkhead, and is a vacuum operated valve controlled, in turn, by an electrically operated solenoid connected to inlet vacuum
- It allows hydrocarbons stored in the EVAP canister to be ingested by the engine
- If it sticks open the engine will run lean and possibly misfire, and the fuel adaptive values will change (to try to compensate).
- Fault Codes
  - P0441 – Purge valve flow fault
  - P0443 – Purge valve open or short circuit



# Canister Vent Solenoid

- EVAP Canister Vent Solenoid (CVS)

- This is located on the EVAP canister, which is on the right side of the fuel tank, and accounts for the missing 3 gallons in the “advanced evaps” cars which have a 12 Gallon (US) tank instead of the 15 gallon tank formerly fitted
- It is used during the fuel system pressure test carried out automatically by the ECM as part of the tank leak check.

# Engine Coolant Temp Sensor

- Engine Coolant Temperature (ECT)
  - Part Number: ETC8496
  - This sensor is located on the top front of the engine. The output varies from 28 KOhms at -30 deg C to 90 Ohms at 130 deg C. The resistance at 85 deg C is 300 Ohms.
  - In the event of failure the Intake Air Temperature will be used at start, and then ramped to the nominal operating temperature over some time. The failure “may not be evident to the driver” but there may be a hot restart problem. The fault will illuminate the MIL light on NAS vehicles.

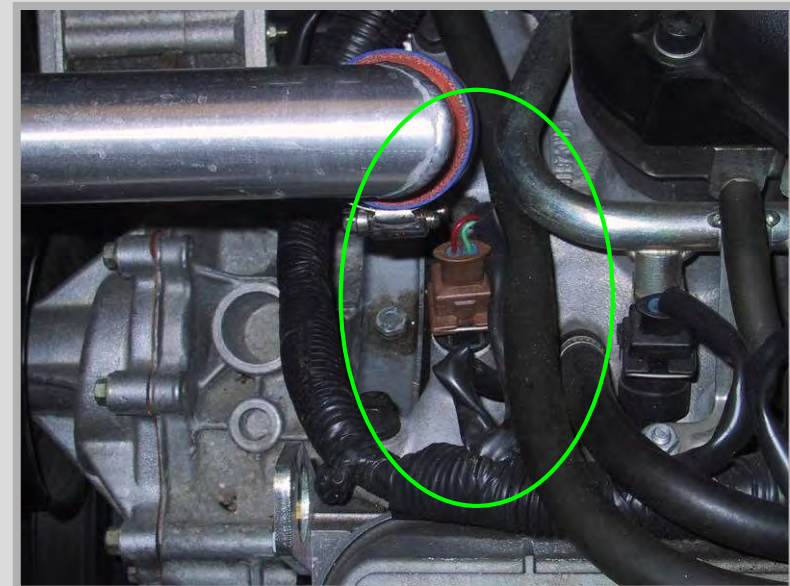

# Engine Fuel Temp Sensor

- Engine Fuel Temperature (EFT)
  - Part Number: ETC8496
  - This sensor is located on the fuel rail on the left front of the engine, and is used to modify injector pulse width during hot restarts.
  - A nominal value is used in the event of a failure, which may cause a hot restart problem. The fault will illuminate the MIL light on NAS vehicles.

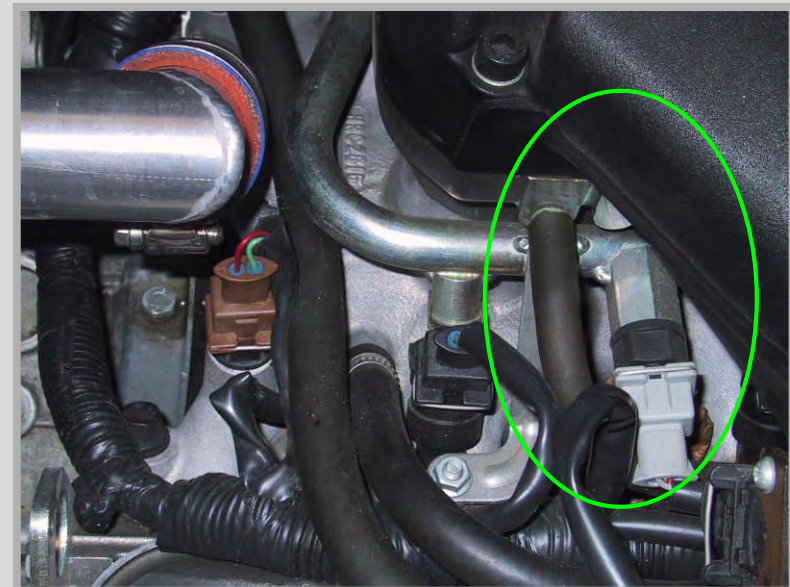

# Fuel Filter

- Fuel Filter (FFTR)
- Part Number: WFX101020
- The Fuel Filter is located on the right hand side of the bulkhead. It can be removed using the following procedure:
  - De-pressurize the fuel system at the pressure test valve. The easiest way is to use a pressure test gauge with a vent line, but failing this a rag can be used to stop fuel spraying over the engine as the center of the valve is depressed.
  - Push the connectors at each end of the filter inwards and then press the locking tabs down. The connectors will then slide off the filter body.



# Fuel Injectors

- Each injector comprises a small solenoid which is activated by the ECM using a PWM signal to allow a metered quantity of fuel to pass into the combustion chamber
  - In the unlikely event of total injector failure or leakage which will cause a rich mixture, a misfire will occur in the affected cylinder
  - The fault is indicated by illumination of the malfunction indicator light (MIL) on North American specification vehicles.
- **CAUTION:** When assembling the injector to the fuel rail, only use clean engine oil to aid assembly
  - DO NOT use petroleum jelly or other forms of grease, as this will contaminate the injector
  - The injectors can be checked using a VOM to test the resistance values:  
injector resistance at 20°C 16.2 ohms  $\pm$  0.5 ohms

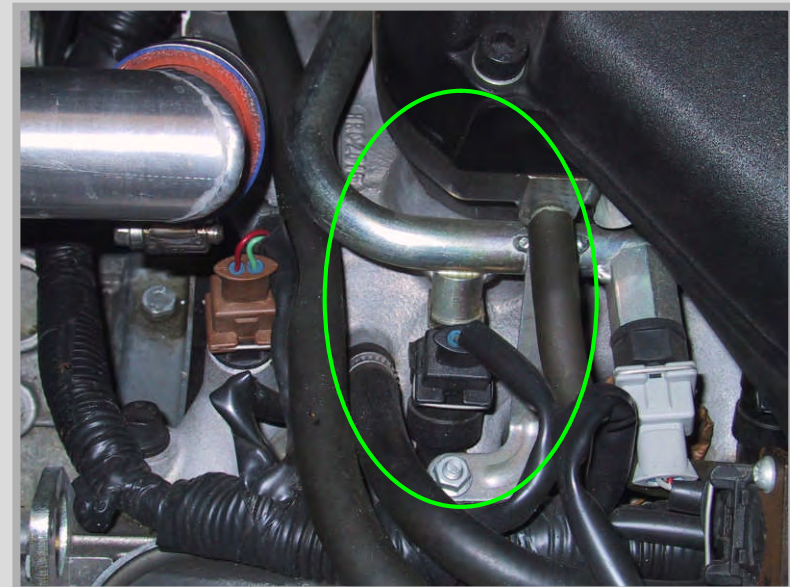

# Fuel Injector Fault Codes

- P0201 - Injector circuit fault, cylinder 1
- P0202 - Injector circuit fault, cylinder 2
- P0203 - Injector circuit fault, cylinder 3
- P0204 - Injector circuit fault, cylinder 4
- P0205 - Injector circuit fault, cylinder 5
- P0206 - Injector circuit fault, cylinder 6
- P0207 - Injector circuit fault, cylinder 7
- P0208 - Injector circuit fault, cylinder 8
- P1201 - Injector circuit open or ground short, cylinder 1
- P1202 - Injector circuit open or ground short, cylinder 2
- P1203 - Injector circuit open or ground short, cylinder 3
- P1204 - Injector circuit open or ground short, cylinder 4
- P1205 - Injector circuit open or ground short, cylinder 5
- P1206 - Injector circuit open or ground short, cylinder 6
- P1207 - Injector circuit open or ground short, cylinder 7
- P1208 - Injector circuit open or ground short, cylinder 8



# Fuel Pressure Regulator

- Fuel Pressure Regulator (FPR)
  - This is a mechanical vacuum-operated device on the left rear of fuel rail
  - It maintains the fuel rail at a 35 psi pressure with respect to the inlet manifold.
  - It can be checked by connecting a fuel pressure tester and turning the ignition ON without starting the engine.
  - It controls fuel pressure by venting it back to the tank to maintain a constant pressure with respect to manifold depression
  - Failure will result in “a rich mixture at idle but normal at full load, or a rich mixture resulting in engine flooding, or a weak mixture”
  - Since it is mechanical there will be no associated MIL light, but it may cause other symptoms that will illuminate the light



# Fuel Pump

- Part Number: WFX101020
- The Fuel Pump is located in the fuel tank, and mounted in an assembly which also includes the fuel level sensor and the Fuel Tank Pressure Sensor (FTPS)
- It can be removed without removing the tank, but the tank should be emptied and unbolted so that it can be lifted at the front edge to allow the pump assembly to clear the wooden frame above it
- It has two connectors – the front one has three pins and connects to the FTPS, the rear one has four pins and connects to the fuel level sensor and the fuel pump

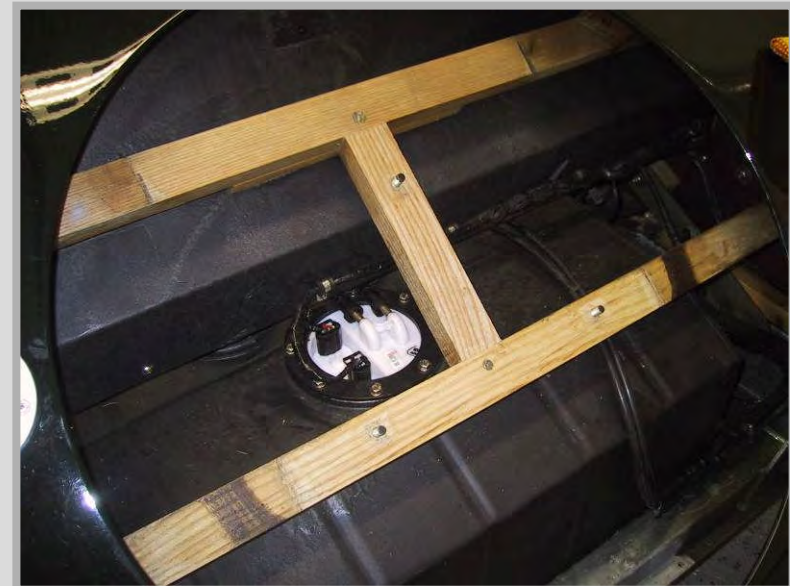

# Fuel Tank Pressure Sensor

## ■ EVAP Fuel Tank Pressure Sensor (FTPS)

- This is located in the fuel tank sender unit and is used to monitor tank pressure during the evaporative leak test, when the fuel tank is depressurized by GEMS using inlet vacuum, and then measures pressure drift over a period
- This sensor, together with the canister purge valve and the CVS is part of the Advanced Evaps Systems which was introduced sometime around 2000/2001 after the supply of '98 engines dried up (probably at the same time the KS were removed)
- The failure of the EVAPS test will illuminate the MIL light on NAS vehicles, and there are also error codes for the individual components
- Fault Codes
  - P0451 – Fuel Tank Pressure Sensor poor performance
  - P0452 - Fuel Tank Pressure Sensor low range fault
  - P0453 - Fuel Tank Pressure Sensor high range fault



# IACV Actuator - 1

- Idle Air Control Valve (IACV)
  - Part Number: ERR4352
  - Gasket: ERR3359
  - Bleed air bypass blanking plug: ETC 6874
  - The idle speed control stepper motor is located on the side of the inlet manifold. Idle speed is controlled by the stepper motor, which comprises two coils, mounted to the throttle housing
  - When energized in the correct sequence the coils move a plunger which opens or closes the throttle bypass valve controlling the quantity of idle air
  - The stepper motor controls idle speed by moving the plunger a set distance called a step
  - Fully open is 200 steps (180 steps for pre-advanced evaps vehicles) and fully closed 0 steps
  - It must be set to between 15 and 30 steps at hot idle by the adjustment of the bleed air bypass, located under a blanking lug on top of the throttle body, to ensure stable idle operation
  - Failure of the stepper motor will result in low or high idle speed, poor idle, engine stall or non start

# IACV Actuator - 2

- If the number of recorded steps changes beyond a set threshold (opening or closing) without a corresponding change in airflow, then a fault code will be stored
- The GEMS diagnostics also check for short circuit conditions during normal stepper operation and open circuit during power down. Detected faults are indicated by illumination of the malfunction indicator light (MIL) on North American specification vehicles
- The IACV may become contaminated or oxidized in vehicles that are not driven often, and this may result in an unreliable idle. If this occurs the IACV should be removed and the pintle valve and housing cleaned with carburetor cleaner.
- CAUTION: The pintle must not be moved by force
- The stepper motor coil resistance is 53 ohms  $\pm$  2 ohms
  - Fault codes:
    - P0506 - Low idle speed
    - P0507 - High idle speed
    - P1508 - IACV stepper motor open circuit
    - P1509 - IACV stepper motor short circuit
  - There is no default strategy, and the fault will illuminate the MIL light on NAS vehicles

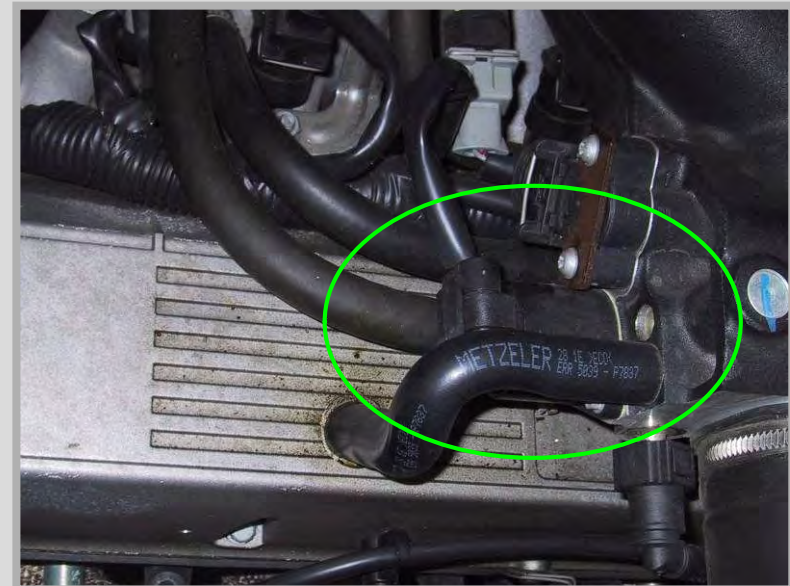

# Inertial Cutoff Switch

## ■ Inertial Cutoff Switch (IS)

- The inertial cutoff switch is located on the left front bulkhead
- It is activated by impacts to the car sufficient to produce local accelerations in the switch body which will cause it to trigger, when it disconnects power to the fuel pump
- It is possible that it can be activated during normal driving conditions, and it should be checked if the engine fails completely with no obvious failure in any related systems (mechanical, power, cranking current)
- It is reset by pressing the rubber cover on the top of the switch.

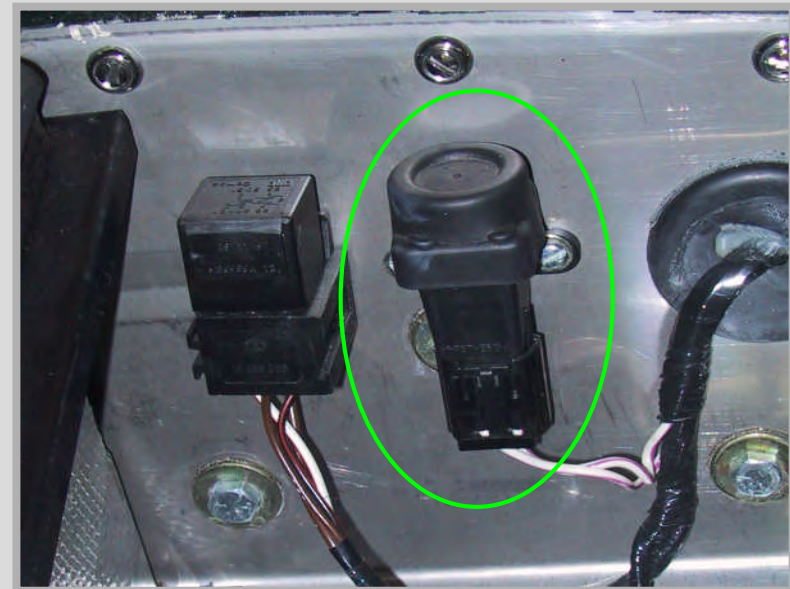

# Inlet Air Temperature Sensor

- Intake Air Temperature Sensor (IAT)

- Part Number: ETC8496

- This sensor is located in the hose leading to the air cleaner. The signal is used to retard the ignition when the air temperature is above 55 degrees.

- If the sensor fails a nominal value will be used. The fault will illuminate the MIL light on NAS vehicles.



# Knock Sensors - 1

## ■ Knock Sensors (KS)

- Part Number: ERR5594

- These sensors are located on either side of the engine on the crankcase below the exhaust manifolds. They have not been fitted by Morgan (well, to be fair, I think that they are in the hands of their engine suppliers) since around 2000/2001, and I presume that the GEMS ignition map was changed at the same time. The ECM calculates knock on a per-cylinder basis, and then progressively retards the ignition (up to 4 degrees I believe) until the knock stops, when it progressively advances it, etc, and then stores the value. In the event of knock occurring each cylinder can (will) have a different ignition timing.

- Sensor failure is detected through background noise being low or high, although this is disabled in the standard Morgan PROMs. The KS are also disabled if the CMP fails since GEMS cannot detect the cylinder that is knocking.

- There are 6 fault codes:

- P0326 – Continuous knock on Bank A
- P0327 – Knock background low, Bank A
- P0328 – Knock background high, Bank A
- P0331 – Continuous knock on Bank B
- P0332 – Knock background low, Bank B
- P0333 – Knock background high, Bank B

- Knock sensor failure will illuminate the MIL light.

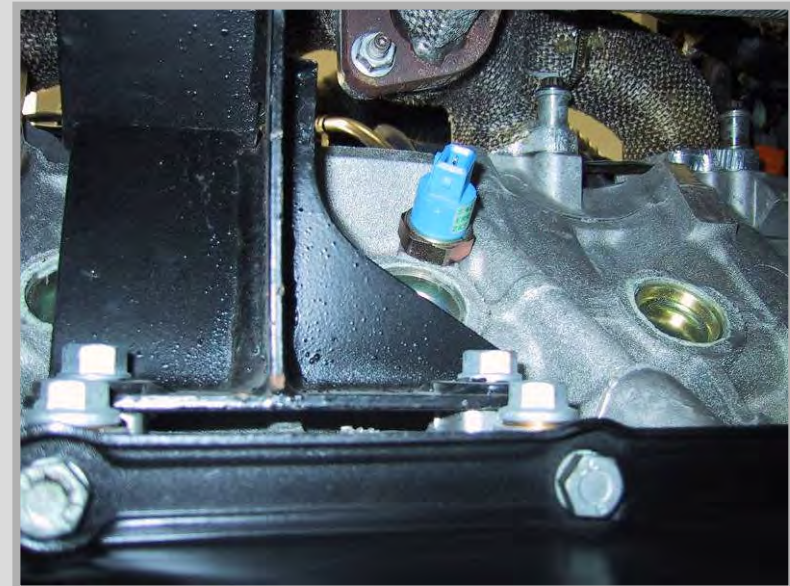



# Knock Sensors - 2

- In cars not fitted with the KS the connectors are taped across the front of the engine (left KS) and to the starter cable (right KS). The picture shows the right hand KS, with the interface cable the “as delivered” configuration strapped to the starter motor cable.



# Mass Air Flow Sensor

- Mass Air Flow Sensor (MAF)
  - Part Number: ERR5595
  - This sensor is located next to the air cleaner. It uses a hot wire to sense air flow, and is the source of one of the primary engine operating parameters.
  - There is no default strategy, and failure will result in the engine starting and then dying when it reaches 550 RPM (when the ECM detects no MAF sensor input). The fault will illuminate the MIL light on NAS vehicles.



# Multi-Function Relay Module

- Multi-Function Relay Module (Main Relay and Fuel Pump) (MRM)
  - Part Number: YWB100820L
  - The main relay and fuel pump relay are contained in a single rectangular Relay Module assembly mounted on a bracket at the rear of the ECM housing module
  - The main relay supplies the power feed to the ECM to feed the fuel injectors (8 amps) and air flow meter (4 amps) (MR)
    - This relay is controlled by the GEMS ECM which has a second power feed, and this enables the ECM to remain powered up after ignition is switched off.
    - During this 'ECM power down routine' the ECM records all temperature readings and powers the stepper motor to the cold start position
    - Failure of this relay will result in the engine management ECM not being powered up, resulting in engine not starting due to absence of fuel and ignition
  - The fuel pump relay provides power to the fuel pump as controlled by GEMS (PR)
    - The pump is operated for about 4 seconds after the ignition switch has been moved to the "run" position
    - If the engine has not started during this period the fuel pump will be shut down.

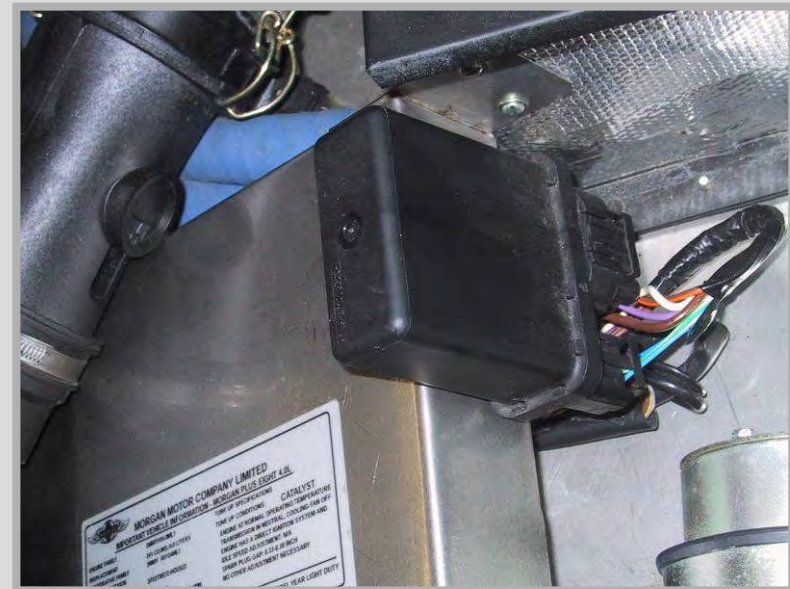

# Oxygen Sensors

- Heated Oxygen Sensor (HO2S) (Lambda Probe)
  - Part Number: ERR1834/AMR6244
  - The oxygen sensors are located in the sections of exhaust pipe in front and behind the catalytic converters, and form part of the closed loop operation of the engine
    - The fuel injection pulse width is modulated by the feedback from front sensors to achieve correct oxygen levels in the exhaust; the rear sensors are used to check correct catalytic converter operation
    - If the connections to the sensors are crossed, one bank will go very rich and the other very lean with black smoke and misfires
  - The heaters are controlled by a pulse width modulated signal, so that the temperature can be controlled during start
    - The oxygen sensors are heated to ensure rapid warm up and continued operation when the exhaust temperature may be below the working temperature of the sensor - both the upstream sensor heaters and the downstream sensor heaters are connected in parallel
  - In the event of an O2 sensor failure, the system will default to 'open loop' operation
    - Fuelling will be calculated using signals from the remaining ECM inputs
    - A fault with any of the HO2S sensors is indicated by illumination of the malfunction indicator light (MIL)
    - ECM diagnostics also use the Heated Oxygen Sensors to detect catalyst damage, misfire and fuel system faults
  - CAUTION: Tighten the sensor to 15lbs/ft when fitting
  - CAUTION: Although robust within the vehicle environment, Heated Oxygen Sensors are easily damaged by dropping, excessive heat and contamination. Care must be exercised when working on the exhaust system not to damage the sensor housing or tip

# Oxygen Sensor Fault Codes - 1

- P0130 - Oxygen sensor circuit slow response, upstream sensor bank A
- P0136 - Oxygen sensor circuit slow response, upstream sensor bank A
- P0150 - Oxygen sensor circuit slow response, upstream sensor bank B
- P0156 - Oxygen sensor circuit slow response, upstream sensor bank B
- P0131 - Oxygen sensor circuit low voltage, upstream sensor bank A
- P0151 - Oxygen sensor circuit low voltage, upstream sensor bank B
- P0137 - Oxygen sensor circuit low voltage, downstream sensor bank A
- P0157 - Oxygen sensor circuit low voltage, downstream sensor bank B
- P0132 - Oxygen sensor circuit high voltage, upstream sensor bank A
- P0152 - Oxygen sensor circuit high voltage, upstream sensor bank B
- P0138 - Oxygen sensor circuit high voltage, downstream sensor bank A
- P0158 - Oxygen sensor circuit high voltage, downstream sensor bank B
- P0133 - Oxygen sensor circuit slow response, upstream sensor bank A
- P0153 - Oxygen sensor circuit slow response, upstream sensor bank B
- P0139 - Oxygen sensor circuit slow response, downstream sensor bank A
- P0159 - Oxygen sensor circuit slow response, downstream sensor bank B
- P1138 - Oxygen sensor problem with switching lean, sensor(s) for bank A
- P1158 - Oxygen sensor problem with switching lean, sensor(s) for bank B
- P1137 - Oxygen sensor problem with switching rich, sensor(s) for bank A
- P1157 - Oxygen sensor problem with switching rich, sensor(s) for bank B
- P1139 - Oxygen sensor circuit switching period too long bank A
- P1159 - Oxygen sensor circuit switching period too long bank B
- P1171 - System too lean bank A and bank B
- P1172 - System too rich bank A and bank B



# Oxygen Sensor Fault Codes - 2

- P0171 - System too lean bank A
- P0174 - System too lean bank B
- P0172 - System too rich bank A
- P0175 - System too rich bank B
- P1185 - Oxygen sensor heater circuit open circuit, upstream sensors
- P1186 - Oxygen sensor heater circuit short circuit, upstream sensors
- P1187 - Oxygen sensor heater circuit inferred open circuit, upstream sensors
- P1188 - Oxygen sensor heater circuit high resistance, upstream sensors
- P1189 - Oxygen sensor heater circuit inferred low resistance, upstream sensors
- P1190 - Oxygen sensor heater circuit low resistance, upstream sensors
- P1191 - Oxygen sensor heater circuit open circuit, downstream sensors
- P1192 - Oxygen sensor heater circuit short circuit, downstream sensors
- P1193 - Oxygen sensor heater circuit inferred open circuit, downstream sensors
- P1194 - Oxygen sensor heater circuit high resistance, downstream sensors
- P1195 - Oxygen sensor heater circuit inferred low resistance, downstream sensors
- P1196 - Oxygen sensor heater circuit low resistance, downstream sensors
- P0420 - Catalyst efficiency is low, bank A
- P0430 - Catalyst efficiency is low, bank B

# Starter Motor Relay

## ■ Starter Motor Relay (SR)

- The Starter Motor Relay is located on the bulkhead next to the fuel pump inertia switch. It provides power to the starter motor as controlled by GEMS
- If the security lockout function has been triggered GEMS will not provide power to the starter motor, the injectors, or the ignition systems.
- The starter motor can be operated with the ignition OFF in order to test cylinder compression or for other reasons by connecting the wires from the contact pins on this relay. A remote starter switch can be purchased from an automotive supplier and modified for this purpose by the addition of two male spade fittings in place of the crocodile clips normally fitted.

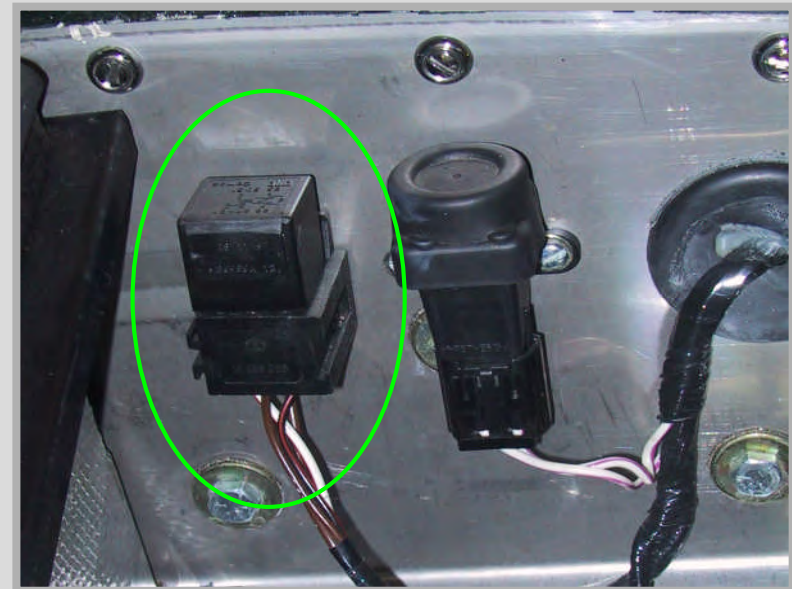

# Throttle Position Sensor

- Throttle Position Sensor (TP)

- Part Number: ERR4278

- Mounting Plate: ERR5023

- This sensor is mounted on the throttle body in line with the throttle shaft. The signal varies from 0 to 5 volts, and is used (mainly) for acceleration and idle purposes. If it is changed the GEMS closed throttle voltage must be reset..

- There is a default strategy. GEMS correlates throttle position with the corrected MAF, which in turn is correlated against the fuel data (injector pulse width, RPM, lambda probe data). If the TP data does not correlate correctly the TP is assumed to have failed and GEMS calculates default data from corrected MAF, which may “adversely affect acceleration performance”. The fault will illuminate the MIL light on NAS vehicles.

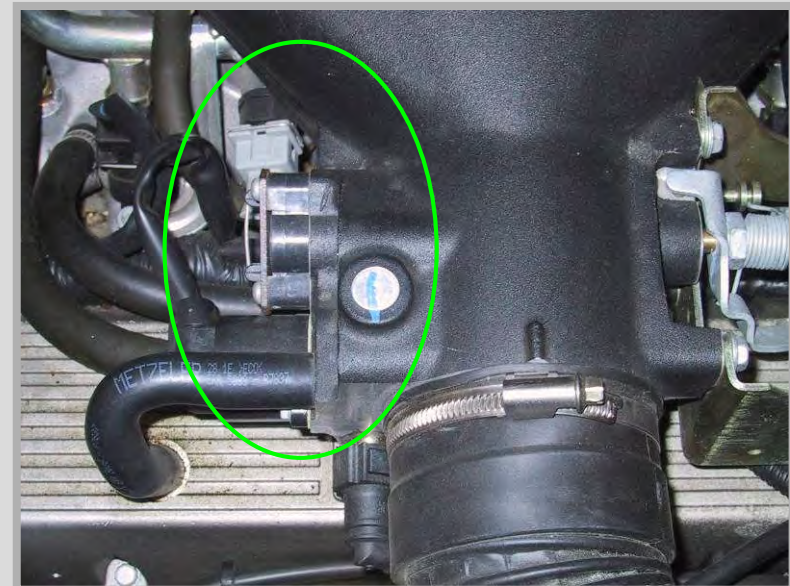



# Other Interfaces

- Vehicle Speed
  - The vehicle speed sensor is located on the lower left hand side of the gearbox
  - It provides a square wave input to GEMS proportional to road speed (8000 pulses/mile), and is also used by the speedometer
- Transmission
  - There is provision for three inputs and outputs to the transmission; the inputs are Park/Neutral selector input, Ignition retard request and Low Gear Transfer range selected
  - The outputs are the Engine Torque, Engine Speed and Throttle Angle
  - None of these interfaces are used in the Plus 8 or vehicles fitted manual transmission.
- Fuel Level and Fuel Totalizer
  - There is an input for fuel level, to prevent the GEMS from adapting to changes in engine operating conditions caused by low fuel levels, and there is also a fuel totalizer output.
  - Neither is used in the Plus 8.
- Security System
  - The Plus 8 is fitted with the Lucas 10AS secure immobilization system
  - This is a complex system that uses a rolling code match between the 10AS and GEMS to enable normal operations
  - It is housed in a grey metal box attached at the center of the frame behind the dashboard, and is capable of number of other functions including welcome and interior light activation, alarm sound and lights flash options, catalyst overheat monitoring, and another 20 or so additional parameters
  - It is programmed through the OBD interface using a specialist module, which can be added to the RovacomLite system.

# GEMS

## Diagnosics

# Diagnostics

- The GEMS system is very robust and the connectors and components are of high quality. Most failures will result in a “Check Engine” light, and the engine will continue to operate more-or-less normally. There are only two sensors the failure of which will cause the engine to stop – these are the CKP and the MAF. The fuel pump is also (obviously) a critical component.
- The “Check Engine” light can be reset and the associated DTC can be read with any OBD-II diagnostic tool for the Chrysler/Import (ISO-9141) standard. Most DTCs will point to an obvious problem, and the generic OBD data will help find any component that has failed, such as temperature sensors. The only functions that require a GEMS-specific diagnostic system are the manual/automatic and capacity settings, adaptive parameter reset, idle setup and security settings.
- Most failures seems to be associated with the idle performance and the Lucas 10AS security system. Poor idle performance is generally due lack of maintenance which will result in a misadjusted or dirty IACV. The Lucas 10AS system is complex and easy to mis-configure, which will result in odd operational characteristics.

# Diagnostics – Failure to Start

- These procedures assume that the battery is charged and is capable of turning the engine over, and that no DTCs have been set.
- Fuel pump operates, and engine turns over but does not start. No “check engine” light with the ignition on.
  - This usually indicates that the security is armed. Attempt to disarm it by cycling the PLIP several times. If this fails a Rovacom will have to be used to perform a Security Learn procedure.
- “Check engine” light on with the ignition, engine turns over and attempts to start but then stops.
  - Check that the fuel pump runs briefly when the ignition is turned on. If you do not hear the fuel pump check the fuses. If the fuse is normal the fuel pump has failed and must be replaced.
  - If you do hear the fuel pump it is probable that the MAF sensor has failed and must be replaced.

# Diagnostics – Poor Idle

- If no sensors have failed a poor or unreliable idle is usually caused by either a dirty IACV or by the bleed air bypass setting being incorrect.
- The IACV setting should be checked using Rovacom. It should be between 15-30 steps with the engine fully warmed and at idle. If it is not in this range the bleed air bypass should be adjusted. If it is in this range the IACV should be removed and cleaned.
- The Stored Throttle Value should be checked using Rovacom – it should be the same as the Current Throttle Position value. If the two values are different an “Adaptive Reset” should be performed and the values checked after performing a Drive Cycle. If the two values are again mismatched the TPS is faulty and should be replaced.
- If neither of the above correct the problem the IACV should be removed and the IACV and housing cleaned with carburetor cleaner or similar. Take care not to move the pintle valve while you are cleaning it.

# Diagnostics - Misfire

- A misfire can be caused by a number of things, including mechanical and electrical items not monitored by GEMS. However, there have been reported instances of the Crankshaft Position Sensor hitting the flywheel reluctor ring and causing an intermittent misfire.
- This condition usually occurs when the clutch is pressed, which causes the crankshaft to move to the fully forward position within the normal clearance in the bearings. Evidence of contact can clearly be seen if the CKP is removed, when a witness mark on the tip of the sensor from contact with the reluctor ring will be seen.
- The CKP sensor is mounted in a sleeve which is bonded to the crankcase. The fault is usually caused by the sleeve becoming loose, although in some cases it may be due to inadequate clearance when initially installed.
- If this condition occurs the mounting sleeve should be re-bonded using a two-part epoxy so that there is approximately 0.020 in clearance between the sensor tip and the flywheel. If this is not possible the sensor tip may be carefully ground to provide the correct clearance.
- The sensor is magnetic, and care should be taken to avoid contaminating it with magnetic debris – which may also cause a misfire.

# GEMS

## Maintenance Procedures

# Maintenance Procedures

- There are a few maintenance procedures that are required. Apart from replacing failed components the most common routine procedure that is required is the measurement of the IACV setting and adjustment of the bleed air valve.
- If the car is to be tested for emission compliance in the USA the OBD interface connector will need modification, and a drive cycle should be completed if the system has been reset.



# Adaptive Reset Procedure

- When
  - A component has been changed which will affect GEMS operation, a fault has been corrected, or idle performance is poor because of a mismatched stored throttle voltage.
- Why
  - GEMS stores adaptive data in PROM memory. The Reset procedure zeros all the data values and sets the stored throttle value to 8.5 volts so that it can be re-learned.
- How
  - Use TestBook or Rovacom to reset GEMS.
  - Go to the “Other” menu and command the reset.
  - After the reset it may take several attempts to start the engine if the bleed air valve is misadjusted, but it will start in the end as GEMS compensates. The engine should be allowed to warm up and idle for at least two minutes after it is hot to allow idle learn
  - It will take 30 or more miles to learn the new adaptive parameters
  - The adaptive parameters can be read, stored and written to the ECM to avoid having to re-adapt
- Note:
  - You can avoid having to re-learn by using the “Read Settings” function and then the “Store Settings” to save the adapted data; they can be reloaded using the “Load Settings” followed by the “Write Settings”. TestBook implements this under the “Change ECM” procedure.

# Security Learn Procedure

## ■ When

- The GEMS ECM or PROM have been changed or the car fails to start because a security problem.

## ■ Why

- When the ignition is turned on, the Lucas 10AS Module, providing it is in receipt of a valid mobilization code and is therefore not in an alarmed or immobilized state, sends a coded signal to the GEMS which it then compares against a mobilization code it has stored. If the two codes are the same GEMS will allow the engine to start. If the GEMS ECM or PROMS are replaced the GEMS must re-learn a new mobilization code

## ■ How

- Go to the “Other” menu and use Rovacom to command the Security Learn mode, and then cycle the ignition. The next coded signal GEMS receives is not compared but is instead stored as the master copy.

# Idle Setup Procedure - 1

## ■ When

- The engine exhibits poor idle quality or will not idle at all.

## ■ Why

- The main contributor to idle problems on the GEMS cars (other than complete failure of the Idle Air Control Valve (IACV) or a sensor - such as water temperature) are the setting of the Bleed Air Bypass and the Stored Throttle Voltage.
- If the stored throttle voltage does not match the current throttle voltage when the throttle is closed GEMS will not recognize the closed throttle condition.
- If the IACV is outside the range of 15-30 steps it will not operate in a linear manner, and the idle will be unstable. Slight wear in the throttle body after some use appears to cause the butterfly to fit more accurately in the throttle body, and thus reduces the nominal air bypass that leaks around the sides of the butterfly. The IACV compensates for this by opening a few more steps, and after it exceeds 30 steps or so a variety of idle problems will start to occur

## ■ How

- Use Rovacom to read the IACV position and the stored throttle voltage. If the stored throttle voltage does not match the current throttle voltage at idle carry out the Adaptive Parameter rests Procedure. If the IACV is not in the range of 15-30 steps with a hot engine warn adjust the bleed air bypass.
- The Bleed Air Bypass is under the blanking plug on the left top of the throttle body, next to the throttle shaft, and the plug can be removed by drilling a small hole in it and the using a self tapping screw and some pliers. It should be adjusted set so that the IACV is between 15 and 30 steps (22 is ideal) at idle with a hot engine. A new blanking plug is available from LR dealers, part number ETC 6874. It should be inserted using a wooden drift and a mallet.

# Idle Setup Procedure - 2

- This shows an Allen key in the bleed air bypass valve, which is hidden under a blanking plug on top of the throttle body

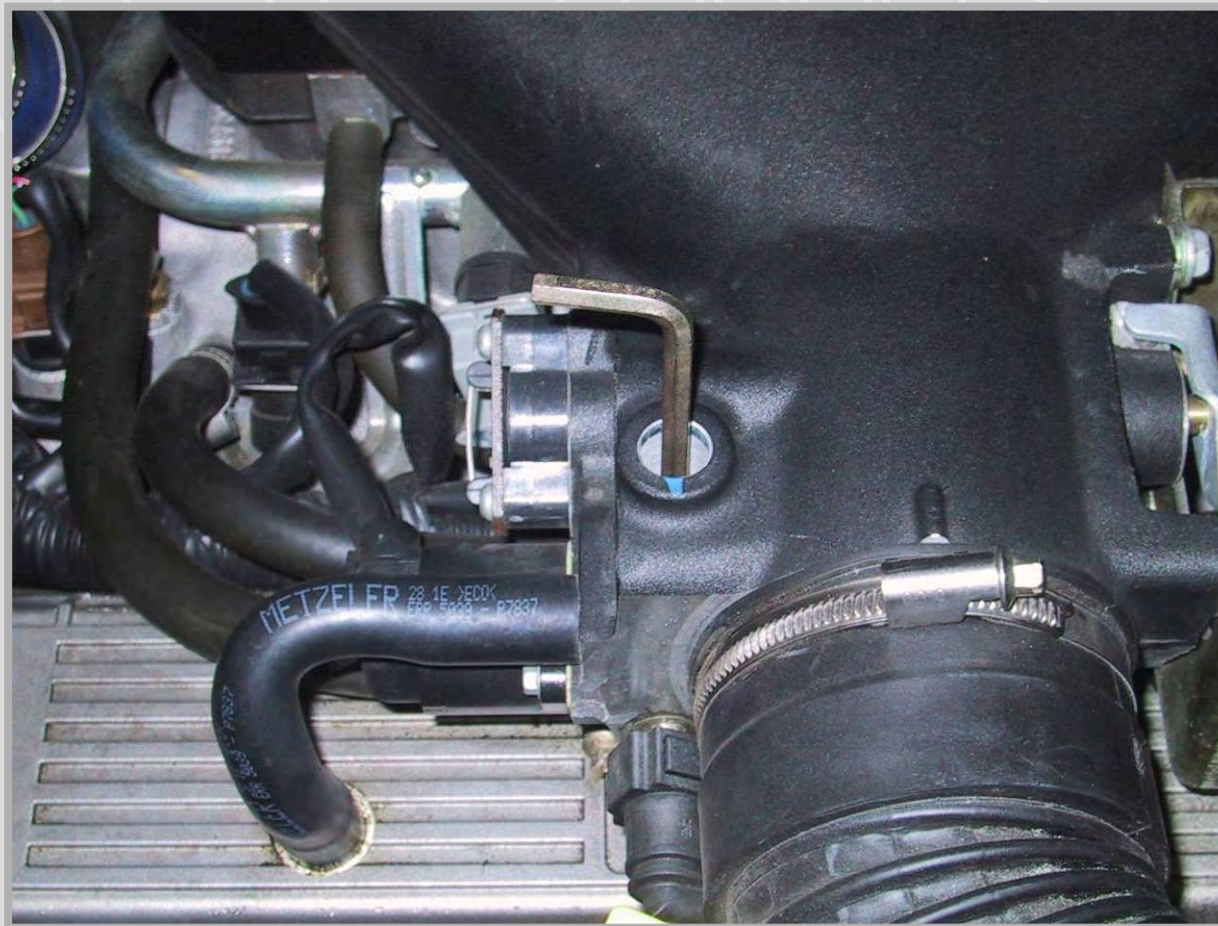

# Idle Setup Procedure - 3

- If you do not have access to a Rovacom the bleed air valve can be adjusted using an empirical procedure, but final IACV setting can not be determined precisely
- The procedure is to open the bleed air bypass valve until the RPM just start to increase, and then screw the valve in by  $1 \frac{1}{4}$  turns
- It is difficult to judge the exact point at which the RPM start to increase, and some care should be taken to ensure that it is accurately known
- This procedure is based on the fact that when the RPM start to increase the IACV will be fully closed, and this represents a known datum for the adjustment

# Lucas 10AS Reset Procedure

## ■ When

- The 10AS should be reset if the GEMS “Security Learn” procedure fails to work, or if other anomalies occur in the operation. Late model EU cars have this system set to auto-arm, and this can prove annoying. This procedure will disable the auto-arm and set the system to the NAS specifications.

## ■ Why

- The 10AS is a complex system with many sophisticated features, and it can be used in combination with four different ECMs. Although system settings are stored in non-volatile ROM it is possible for the system to be mis-configured during servicing.

## ■ How

- Select “Restore the Default setting” on the “Other” page of the 10AS menu.
- Select the data page
- Set “GEMS” as the ECM type on the lower part of the page.
- Set the other values to those shown on the example pages titled Lucas 10AS Security Module 1 & 2 up to (and including the ‘Vehicle Type’ setting.
- Perform the GEMS “Security Learn” procedure.

# 10AS Add PLIP Procedure

## ■ When

- You need to add a new PLIP or relearn an existing one following a PLIP battery change.

## ■ Why

- The 10AS can earn up to four PLIPS, and each one will have a different code. The PLIPS are LUCAS 17TN, but this part number has been used for a variety of different internal modules, from TXA through to TXD. They are available in four different frequencies, as follows:
    - **224.5 MHz** FRANCE
    - **315.0 MHz** REST OF THE WORLD (including ITALY, AUSTRALIA, JAPAN, US)
    - **418.0 MHz** CANADA, UK-IRELAND (changed to 433.9mhz after 1995)
    - **433.9 MHz** EUROPE (not France or Italy)
  - The frequency is not shown on the outside of the PLIP (usually) but if you open it up you can see a small metal canister (round on earlier version, square on later ones). This is part of a Surface Acoustic Wave (SAW) oscillator circuit, and you can tell the frequency from the part number. The round cans have part numbers 1239 for 315MHz. and 1207 for 433.92 MHz, and the square cans have part numbers 2704 for 315 MHz 2701 for 433.92 MHz.
- ## ■ How
- Select the “PLIP Programming (Learn) Mode” on the 10AS “Other” menu and then press the PLIP “repeatedly” until either the relay clicks or the LED flashes (it is meant to be the hazards but they are not connected on the Plus 8).

# GEMS

## RovacomLite



# RovacomLite

- This is RovacomLite. The small silver box is the server, and contains the processor which hosts the web pages used for data display. It has either RS-232 or USB interfaces available, and the server is powered by the OBD connection to the car.



# RovacomLite Menus

- This is the introduction screen for Rovacom Lite. There are many modules available which cover all the different Land Rover and Rover ECM and Security System variants

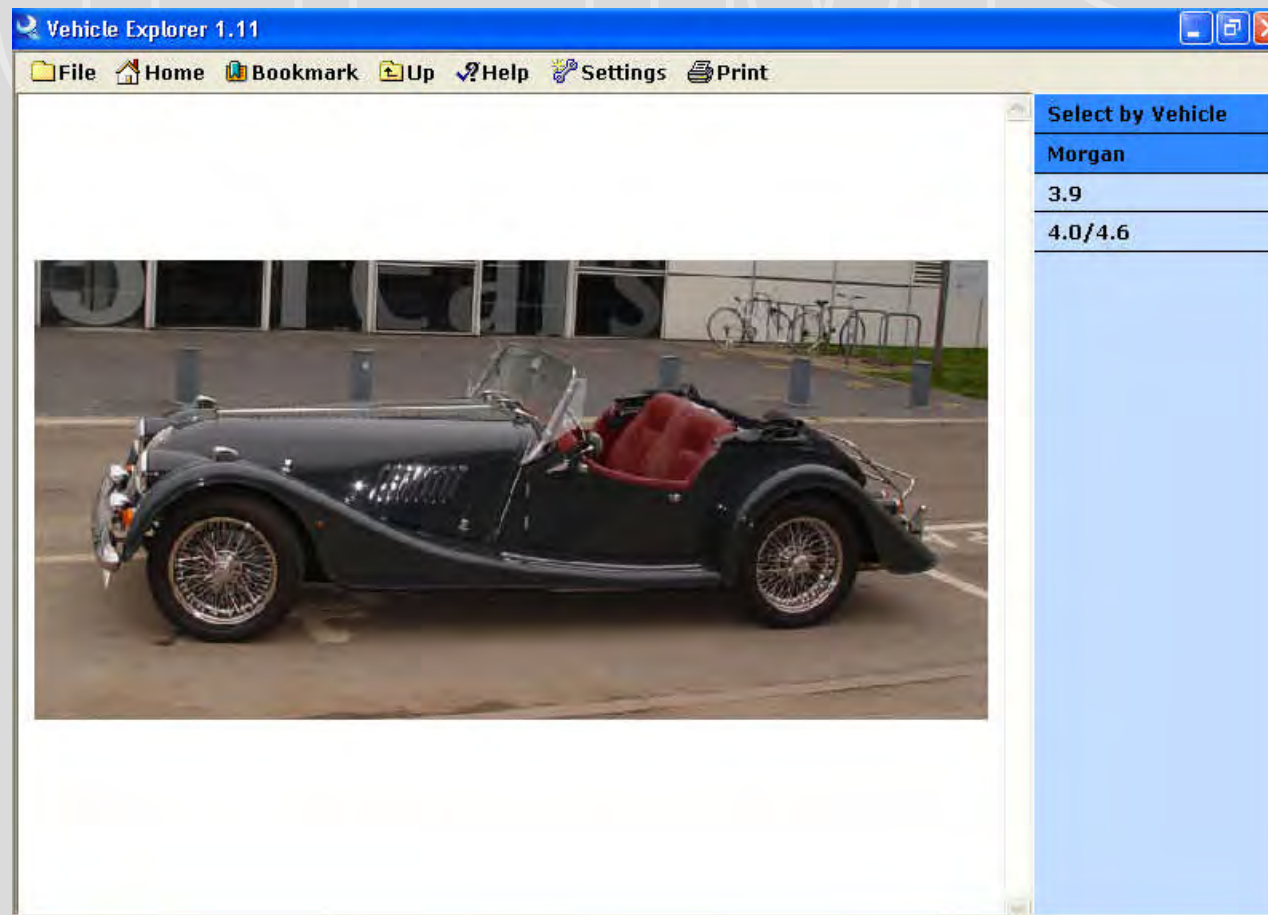

# Read Data

- This screen shows the main setup information and adaptive settings that can be read from the ECM
- This data can be saved and/or modified and re-written

The screenshot displays the 'Vehicle Explorer 1.09' application window. The left sidebar contains a menu with options: Morgan, 4.0/4.6, Petrol Engine Management, 2000-, GEMS, Brief Information, Lead, Connector Picture, Connector Diagram, Read Fault Codes, Clear Fault Codes, Read Settings (highlighted), Write Settings, Store Settings, Load Settings, Inputs, Outputs, Other, Sleep, and Help. The main area shows three tables of GEMS settings and information.

GEMS SETTINGS / INFORMATION - VEHICLE CONFIGURATION											
SECURITY		DEALER ID		LAST 6 No. OF VIN							
0	0	0	0	0	0	0	0	0	0	0	002769
BUILD CODE		GEARBOX		ENGINE		MARKET					
0	0	<input type="radio"/> Manual <input type="radio"/> Auto		<input checked="" type="radio"/> 4.0L <input type="radio"/> 4.6L		EUROPEAN					

GEMS SETTINGS / INFORMATION - RELEASE INFORMATION		
GEMS	PATENTED NUMBER	INTEL NUMBER
End of Line - GEMS 8.2	150588	13161
TMS NUMBER	PART NUMBER	ECU TUNE ID NUMBER
13141	MEE1120	9619

GEMS SETTINGS / INFORMATION - STORED ADAPTIVE VALUES		
FUEL FLOW RATE	AIR FLOW RATE	SHORT TERM IDLE
-276	-3	251
LONG TERM IDLE		CLOSED THROTTLE VALUE
255		.625

# Inputs

- This shows the selection sub-menu for the three main data displays available

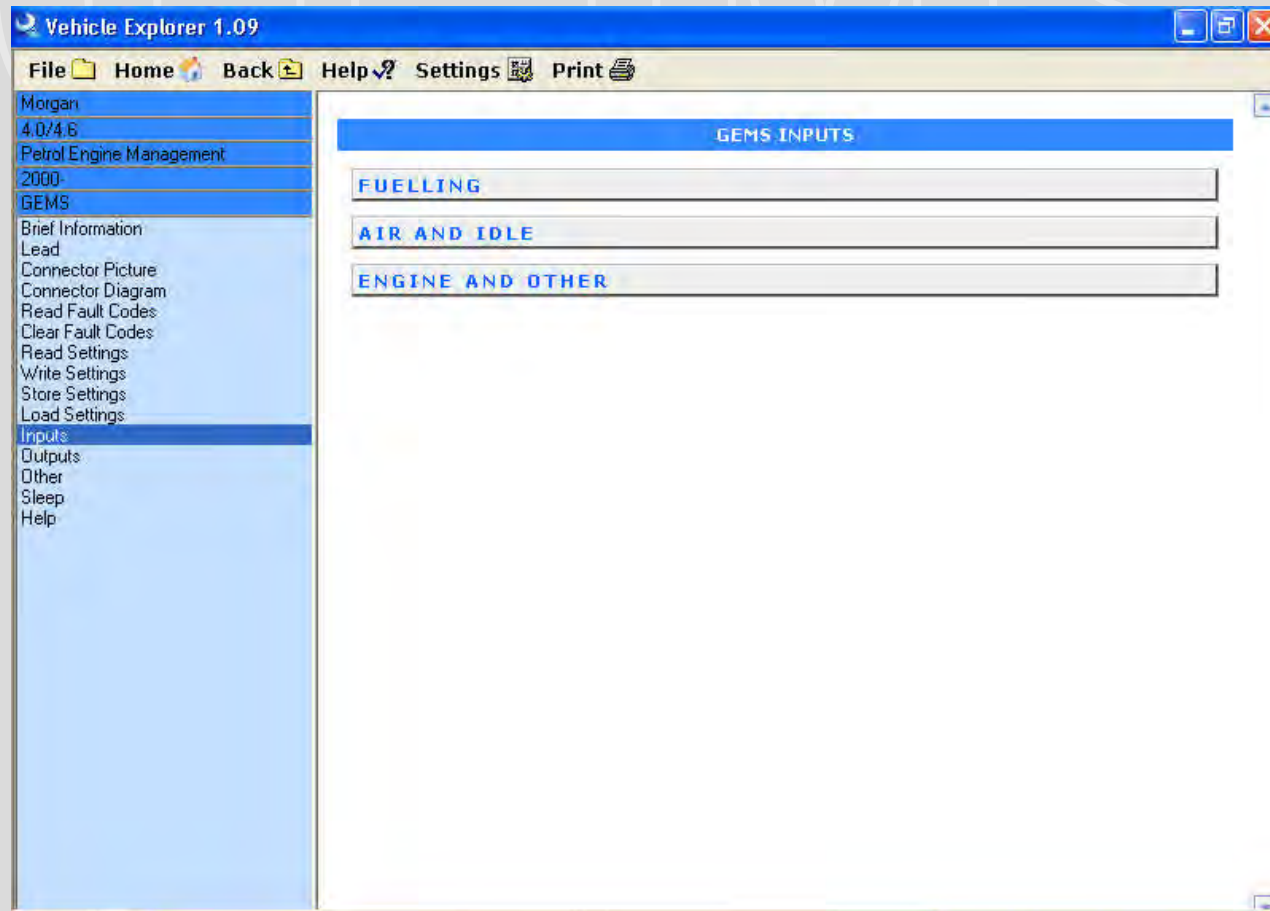

# Fueling

- The Fueling display shows the control loop status as well as the main operational parameters
- The HO2S heaters are wired in parallel so only two values are shown

Vehicle Explorer 1.09

File Home Back Help Settings Print

Morgan  
4.7/4.9  
Parrot Engine Management  
2000  
GEMS  
Brief Information  
Lead  
Connective Picture  
Connector Diagram  
Front Fault Codes  
Clear Fault Codes  
Read Settings  
Write Settings  
Store Settings  
Load Settings  
Inputs  
Outputs  
Dither  
Sleep  
Help

GEMS INPUTS - FUELLING - BANK 1, ODD CYLINDERS (1,3,5,7)		
LOOP STATUS	SWITCHING OUTPUT SENSOR 1	SWITCHING OUTPUTS SENSOR 2
CLOSED LOOP USING O2	4.05	N/F
FUEL TRIM LONG TERM		FUEL TRIM SHORT TERM
-30		-26.3

GEMS INPUTS - FUELLING - BANK 2, EVEN CYLINDERS (2,4,6,8)		
LOOP STATUS	SWITCHING OUTPUT SENSOR 1	SWITCHING OUTPUT SENSOR 2
CLOSED LOOP USING O2	6.2	N/F
FUEL TRIM LONG TERM		FUEL TRIM SHORT TERM
-30		-22.5

OTHER		
FUEL TEMPERATURE	FUEL LEVEL	OXYGEN CONFIGURATION
47	1.15	11
FRONT O2 HEATER	REAR O2 HEATER	ADAPTIVE FMFR
.99	.98	0

CLOSE SAVE

# Air and Idle

- This display shows the main idle settings, as well as the total Mass Air Flow.
- The current throttle position should match the stored throttle position and the IACV should be between 15-30 steps at hot idle; you can see the throttle position matches at 6.2 volts, and the IACV is presently at 19 steps for this car.

The screenshot shows the 'Vehicle Explorer 1.09' application window. The left sidebar contains a tree view with 'GEMS' selected. The main area displays a table titled 'GEMS INPUTS - AIR AND IDLE' with the following data:

CURRENT THROTTLE POSITION (V)	STORED THROTTLE POSITION (V)	ADAPTIVE AIR FLOW VALUE (kg/hr)	CURRENT AIR FLOW (kg/hr)
.62	.62	0	449
INTAKE AIR TEMPERATURE (°C)	AIR FLOW SENSOR VOLTAGE	SECONDARY AIR STATUS	CURRENT RUN LINE POSITION steps
33	1.32	4	20
LONG TERM ADAPTIVE IDLE (steps)	SHORT TERM ADAPTIVE IDLE (steps)	IDLE REFERENCE SPEED RPM	IDLE AIR CONTROL VALVE POSITION (steps)
255	251	708	19
RPM	CURRENT GEARBOX RETARD (%)	CALCULATED LOAD VALUE (%)	CURRENT GEARBOX STATUS (D/P)
698	0	21	D

Below the table are two buttons: 'CLOSE' and 'SAVE'.

# Engine and Other

- This shows a variety of other inputs; the road speed uses a sensor on the transmission which generates 8000 pulses/mile
- The ignition advance at idle is around 28.5 degrees with the MMC PROMS and 15 degrees with the Tornado PROMS

The screenshot shows the 'Vehicle Explorer 1.09' application window. The left sidebar contains a tree view with categories like 'Morgan', '4/27/05', 'Panel Engine Management', '2000', 'GEMS', 'Bial Information', 'Lead', 'Connector Picture', 'Connector Diagram', 'Read Fault Codes', 'Clear Fault Codes', 'Read Settings', 'Write Settings', 'Store Settings', 'Load Settings', 'Inputs', 'Outputs', 'Other', 'Sleep', and 'Help'. The main area displays a table titled 'GEMS INPUTS - ENGINE AND OTHER' with the following data:

GEMS INPUTS - ENGINE AND OTHER			
COOLANT TEMPERATURE (°C)	BATTERY VOLTAGE	ROAD SPEED (mph)	ROAD SPEED (km/h)
91	13.4	0	0
AIR CONDITIONING REQUEST	FRONT SCREEN LOAD	IGNITION SWITCH	ABS VOLTS
OFF	OFF	ON	n/a
SECURITY LEARN	SECURITY MOBILISED	TRANSFER BOX VOLTS	IGNITION TIMING ADVANCE DEG
NO	YES	0	14.5

Below the table are two buttons: 'CLOSE' and 'SAVE'.

# Outputs

- These are the various outputs that can be commanded through the Rovacom
- The main one of interest on the Plus 8 is the fuel pump, which can be commanded ON during pressure tests with the engine stopped
- The outputs revert to their normal state after an ignition OFF/ON cycle

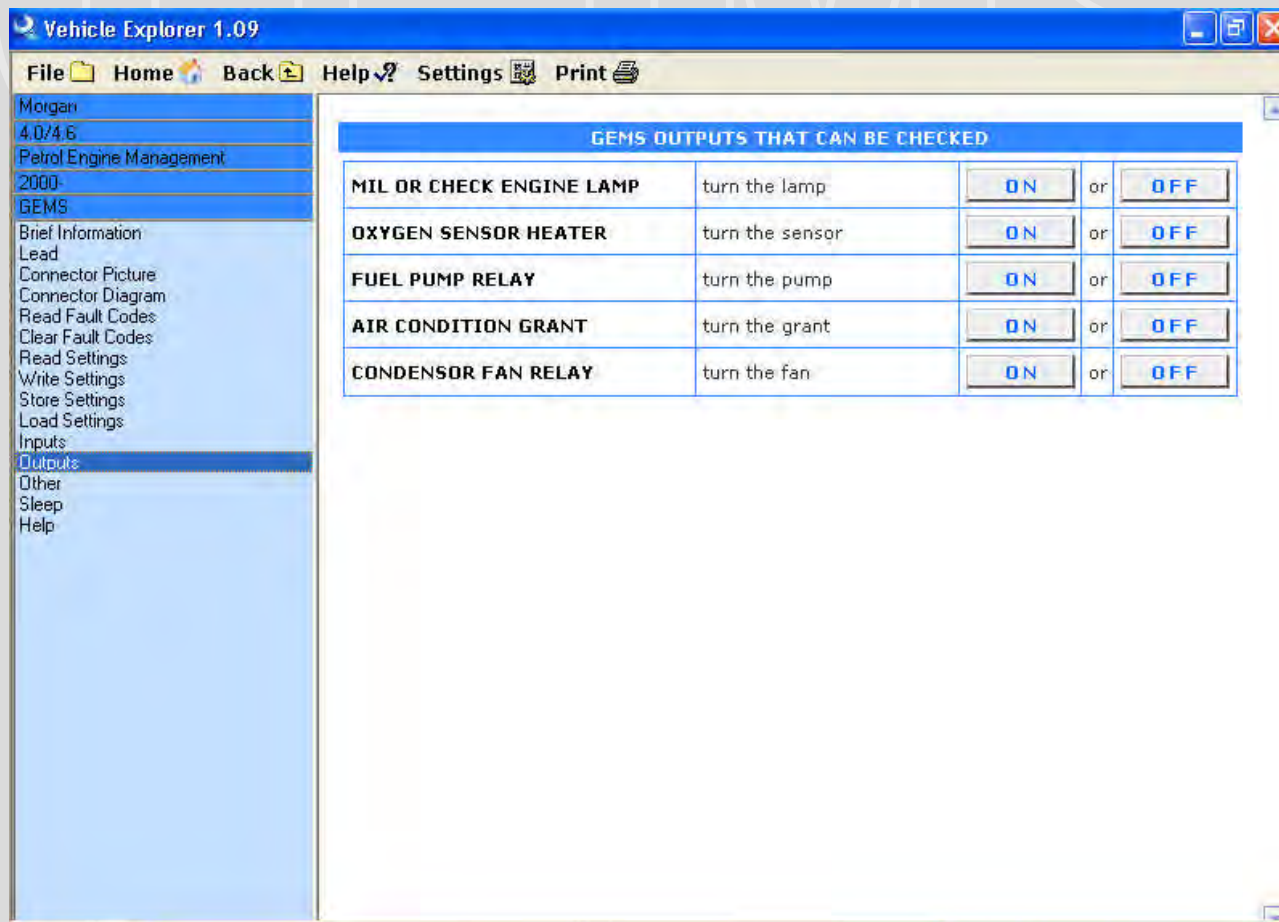



# Other

- This page shows the Security Learn and Adaptive Reset Commands
- There is also a “server reset” command (for the Rovacom server) on the LR menu

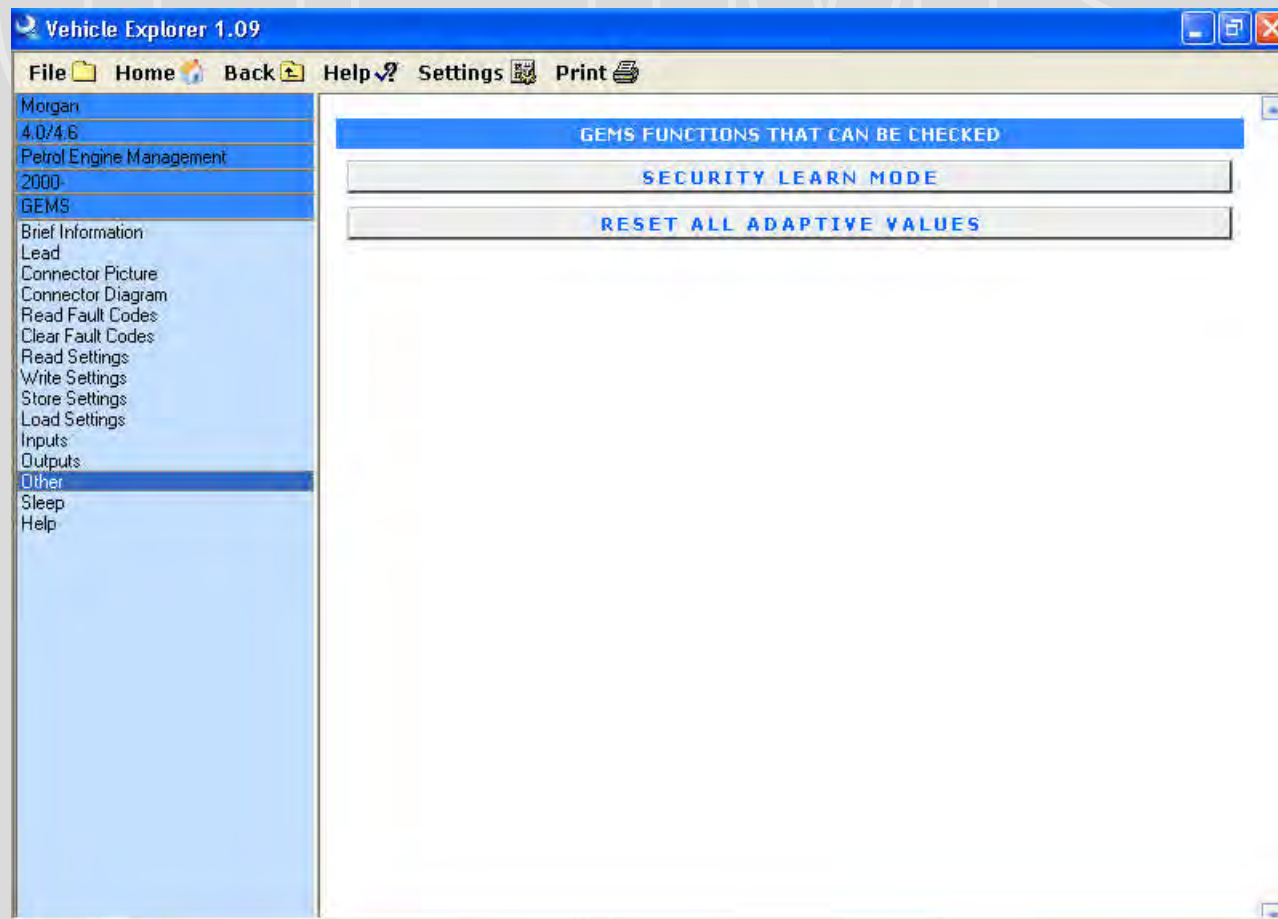

# Lucas 10AS Security Module - 1

- This screen shows the top half of the default settings for the NAS Morgan Plus 8 in the Lucas 10AS Security System. There is a clock in the PLIP and the 10AS, which is used to synchronize the units. If the PLIP is unreliable in operation it is probably because the clock synchronization settings are wrong.

**10AS ALARM SETTINGS**

<b>TIME ERROR</b>	<b>COMMS</b>	<b>INTERIOR LIGHT</b>	<b>WELCOME LIGHT</b>	
<input checked="" type="radio"/> None <input type="radio"/> Allowed	<input type="radio"/> Normal <input checked="" type="radio"/> Smart	<input type="radio"/> Smart <input checked="" type="radio"/> Normal	<input checked="" type="radio"/> Enabled <input type="radio"/> Disabled	
<b>ARM/DISARM FLASH</b>	<b>ARM/DISARM CONFIRM</b>	<b>ARM ON LOCK</b>	<b>RESYNC ON ARM</b>	
<input type="radio"/> No Hazards <input checked="" type="radio"/> Hazards	<input type="radio"/> No Hazards <input checked="" type="radio"/> Hazards	<input type="radio"/> Disabled <input checked="" type="radio"/> Enabled	<input checked="" type="radio"/> Enabled <input type="radio"/> Disabled	
<b>RELOCK</b>	<b>MISLOCK</b>	<b>MISLOCK NOISE</b>	<b>RESYNC ON LOCK</b>	
<input type="radio"/> Enabled <input checked="" type="radio"/> Disabled	<input checked="" type="radio"/> Noted <input type="radio"/> Ignored	<input checked="" type="radio"/> No Noise <input type="radio"/> Enabled	<input checked="" type="radio"/> Enabled <input type="radio"/> Disabled	
<b>PLIP IMMOBILISE</b>	<b>PLIP RELOCK</b>	<b>KEY MOBILISE</b>	<b>PASSIVE IMMOBILISE</b>	
<input type="radio"/> Enabled <input checked="" type="radio"/> Disabled	<input checked="" type="radio"/> Disabled <input type="radio"/> Enabled	<input type="radio"/> Disabled <input checked="" type="radio"/> Allowed	<input type="radio"/> Enabled <input checked="" type="radio"/> Disabled	
<b>KEY DISARM</b>	<b>CDL WHEN ARM</b>	<b>FLASH ON ALARM</b>	<b>ALARM SOUND</b>	<b>TIME SYNC</b>
<input type="radio"/> Disabled <input checked="" type="radio"/> Allowed	<input checked="" type="radio"/> No CDL <input type="radio"/> Active	<input type="radio"/> No Flash <input checked="" type="radio"/> Hazards	<input type="radio"/> Single <input checked="" type="radio"/> Pulsed	<input checked="" type="radio"/> Used <input type="radio"/> Not Used
<b>LOW BATTERY</b>	<b>LOW BATTERY ERROR</b>	<b>TAMPER WARN</b>	<b>MEMS FAILURE INDICATOR</b>	<b>CAT OVERHEAT</b>
<input type="radio"/> Disabled <input checked="" type="radio"/> Enabled	<input checked="" type="radio"/> Use Count <input type="radio"/> Immediate	<input checked="" type="radio"/> None <input type="radio"/> Warn	<input type="radio"/> Enabled <input checked="" type="radio"/> Disabled	<input checked="" type="radio"/> Disabled <input type="radio"/> Enabled
<b>PLIP PRESSES FOR EASY RESYNC</b>	<b>PLIP PRESSES FOR RESYNC</b>	<b>PLIP PRESSES FOR LOW BATTERY ERROR</b>	<b>BAD PLIP KEYCODE ALLOWANCE</b>	
2	4	10	4	
<b>VEHICLE TYPE</b>	<b>ALARM SERIAL NUMBER</b>	<b>WEEK OF BUILD</b>	<b>YEAR OF BUILD</b>	
<input checked="" type="radio"/> Discovery <input type="radio"/> Defender	1295481	21	2001	
<b>IMMOBILISER TYPE</b>				
<input type="radio"/> TD5/MEMS	<input checked="" type="radio"/> GEMS	<input type="radio"/> ENG	<input type="radio"/> DNS	<input type="radio"/> SPIDER

**Select by ECU**

- ECU
- Anti Theft
- Lucas 10AS**
- Information
- Fault Codes
- Settings
  - Read Settings
  - Write Settings
  - Load Settings
  - Store Settings
- Inputs
- Outputs
- Other
- Sleep

# Lucas 10AS Security Module - 2

- This is the lower half of the default settings for the Morgan. If there are problems with 10AS operation the system should be initialized to the default settings on the “Other” screen , and then the Morgan defaults set, including setting the immobiliser type to GEMS. The GEMS “Security Learns” procedure must then be carried out.

Vehicle Explorer 1.11

File Home Bookmark Up Help Settings Print

<input type="radio"/> Enabled	<input checked="" type="radio"/> Noted	<input checked="" type="radio"/> No Noise	<input checked="" type="radio"/> Enabled				
<input checked="" type="radio"/> Disabled	<input type="radio"/> Ignored	<input type="radio"/> Enabled	<input type="radio"/> Disabled				
PLIP IMMOBILISE	PLIP RELOCK	KEY MOBILISE	PASSIVE IMMOBILISE				
<input type="radio"/> Enabled	<input checked="" type="radio"/> Disabled	<input type="radio"/> Disabled	<input type="radio"/> Enabled				
<input checked="" type="radio"/> Disabled	<input type="radio"/> Enabled	<input checked="" type="radio"/> Allowed	<input checked="" type="radio"/> Disabled				
KEY DISARM	CDL WHEN ARM	FLASH ON ALARM	ALARM SOUND	TIME SYNC			
<input type="radio"/> Disabled	<input checked="" type="radio"/> No CDL	<input type="radio"/> No Flash	<input type="radio"/> Single	<input checked="" type="radio"/> Used			
<input checked="" type="radio"/> Allowed	<input type="radio"/> Active	<input checked="" type="radio"/> Hazards	<input checked="" type="radio"/> Pulsed	<input type="radio"/> Not Used			
LOW BATTERY	LOW BATTERY ERROR	TAMPER WARN	MEMS FAILURE INDICATOR	CAT OVERHEAT			
<input type="radio"/> Disabled	<input checked="" type="radio"/> Use Count	<input checked="" type="radio"/> None	<input type="radio"/> Enabled	<input checked="" type="radio"/> Disabled			
<input checked="" type="radio"/> Enabled	<input type="radio"/> Immediate	<input type="radio"/> Warn	<input checked="" type="radio"/> Disabled	<input type="radio"/> Enabled			
PLIP PRESSES FOR EASY RESYNC	PLIP PRESSES FOR RESYNC	PLIP PRESSES FOR LOW BATTERY ERROR	BAD PLIP KEYCODE ALLOWANCE				
2	4	10	4				
VEHICLE TYPE	ALARM SERIAL NUMBER	WEEK OF BUILD	YEAR OF BUILD				
<input checked="" type="radio"/> Discovery	1295481	21	2001				
<input type="radio"/> Defender							
IMMOBILISER TYPE							
<input type="radio"/> TD5/MEMS	<input checked="" type="radio"/> GEMS	<input type="radio"/> EDC	<input type="radio"/> DDS	<input type="radio"/> SPIDER			
NUMBER OF PLIPS LEARNT	CAT OVERHEAT THRESHOLD	VOLUMETRIC SENSOR GAIN					
2	86	28					
PLIP KEYCODE 1			PLIP KEYCODE 2				
137	94	95	186	201	95	120	170
PLIP KEYCODE 3				PLIP KEYCODE 4			
0	0	0	0	0	0	0	0
EKA CODE	EDC CODE	EGR/DDS CODE	GEMS CODE	TD5/MEMS CODE			
8156	3855	54597	53262	4301			

Select by ECU

ECU

Anti Theft

Lucas 10AS

Information

Fault Codes

Settings

Read Settings

Write Settings

Load Settings

Store Settings

Inputs

Outputs

Other

Sleep

# GEMS

## Autotap

# Autotap

- Autotap is one of the many generic OBD diagnostic tools available. It is similar to RovacomLite in that it is hosted on a laptop, but it does not use a remote server and the applications runs on the PC.
- The advantage of Autotap is that it can log engine data in real time, and the resultant data files can then be exported to a spreadsheet for analysis.
- A diagnostic tool such as Autotap is required for general GEMS maintenance since RovacomLite cannot access the OBD Monitors used by the Emission Control tests for post 1995 vehicles. The tests require that all the OBDM (except for a maximum of one) must be set to “Complete”, that the “Check Engine” light works and that it is OFF, and that there are no DTC’s for the vehicle to pass.
- The data rate through the OBD interface depends on the number of parameters selected, so that for reasonable real time performance during full throttle operations only two or three parameters should be selected simultaneously.

# Autotap Data

- This shows the generic data available through the Autotap OBD diagnostic unit. It is hosted on a PC or PDA and can display and log real-time OBD data .
- There are also strip-chart and gauge modules available.

The screenshot displays the 'AutoTap@ Diagnostic Scanner - Connected' application window. The interface includes a menu bar (File, Display, Logging, Playback, Options, Help) and a toolbar with icons for file operations and navigation. A 'Clear DTCs' dialog box is open, showing 'No Trouble Codes Detected'. Below it, a data table displays various OBD parameters. The status bar at the bottom indicates 'VIN NOT DETECTED', 'CFG File: LOG File: Connected: YES', and 'Logging: NO MIL: OFF'.

Parameter	Value	Unit
Calculated Engine Load	20.4	%
Catalyst Monitoring Status	Complete	
Comprehensive Component Monitoring Status	Complete	
Engine Coolant Temperature	201	°F
Engine Speed	705	RPM
Evaporative System Monitoring Status	Complete	
Fuel System Monitoring Status	Complete	
Fuel System Status Bank 1	CL-1	
Ignition Timing Advance	28.5	Deg
Intake Air Temperature	151	°F
Long Term Fuel Trim Bank 1	-10.9	%
Long Term Fuel Trim Bank 2	-10.9	%
Mass Air Flow Rate	0.007	lb/min
Misfire Monitoring Status	Complete	
O2 Sensor - Bank 1 Sensor 1 (mV)	960	mV
O2 Sensor - Bank 1 Sensor 2 (mV)	95	mV
O2 Sensor - Bank 2 Sensor 1 (mV)	25	mV

# OBDM

- This shows the OBD monitors used in the Plus 8 MMC PROMS, and which have to be complete in order to pass the US emissions tests
- The OBD Requirements data shows that the car is certified for sale in California

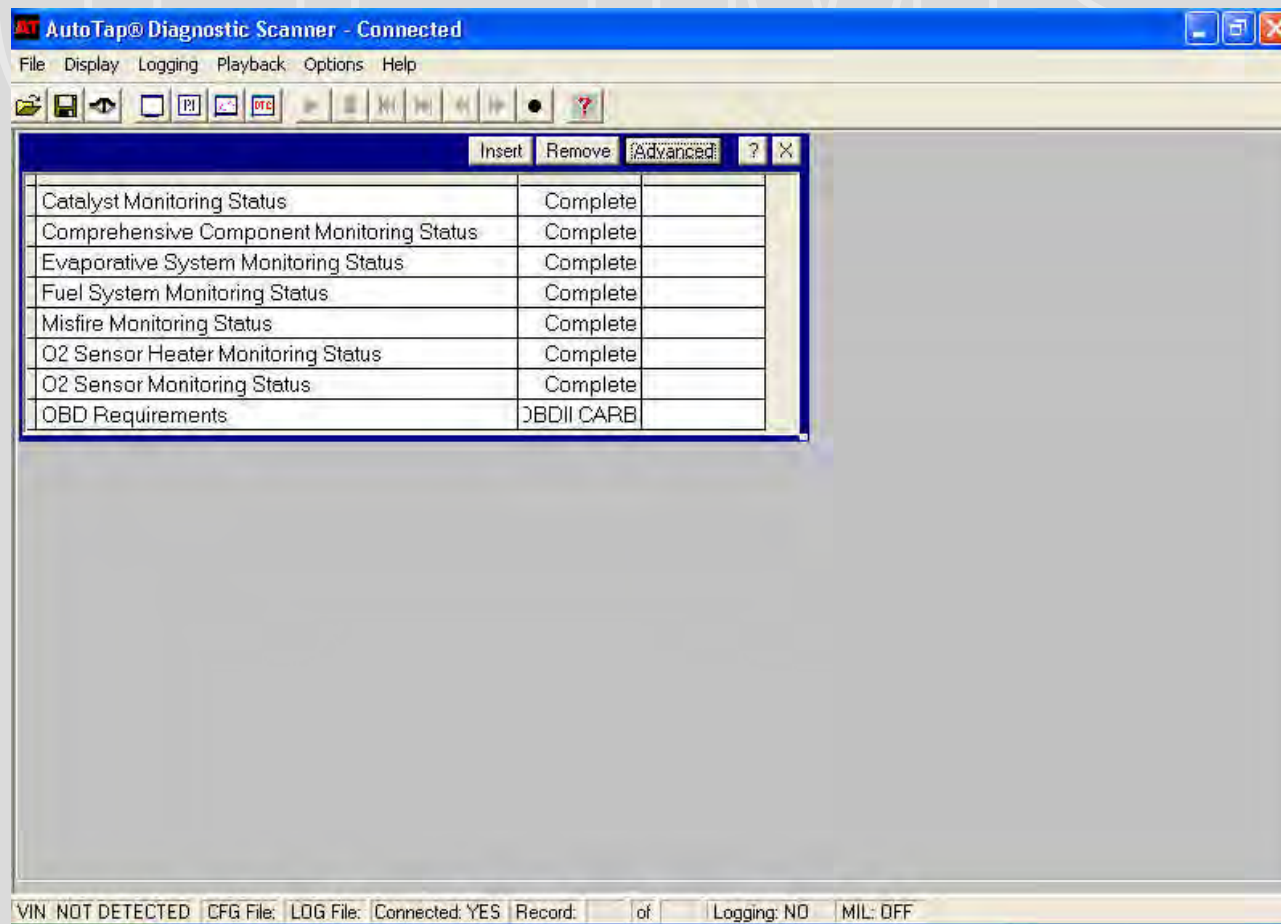

# Full Throttle Accels

- This shows full throttle accelerations logged in real time in Autotap.
- These are similar data obtained on a to rolling road, and can be useful in analyzing engine performance.
- The data rate through the OBD port is dependant on the number of parameters selected, so it unwise to try to capture too much real time data simultaneously.

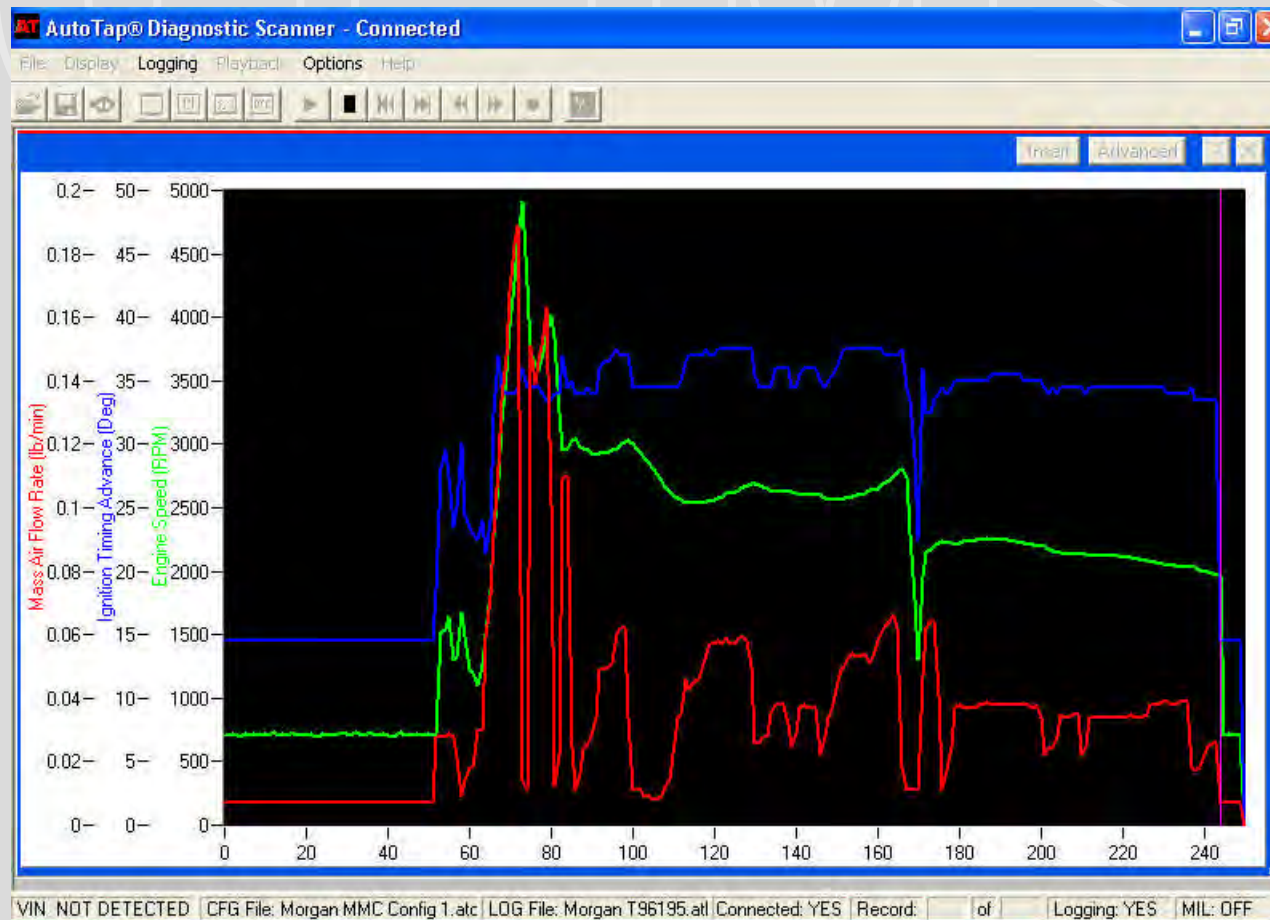



# GEMS

## OBD Generic Trouble Codes

# OBD Generic Trouble Codes

- P0101 - Mass Air Flow Sensor Signal Error Fault  
P0102 - Mass Air Flow Sensor Low Out of Range Fault  
P0103 - Mass Air Flow Sensor High Out of Range Fault  
P0111 - Air Temperature Sensor Signal Error Fault  
P0112 - Air Temperature Sensor Low Out of Range Fault  
P0113 - Air Temperature Sensor High Out of Range Fault  
P0116 - Engine Coolant Temperature Sensor Falling Temp Fault  
P0117 - Engine Coolant Temperature Sensor Low Out of Range Fault  
P0118 - Engine Coolant Temperature Sensor High Out of Range Fault  
P0121 - Throttle Position Sensor Output Signal Error Fault  
P0122 - Throttle Position Sensor Low Out of Range Fault  
P0123 - Throttle Position Sensor High Out of Range Fault  
P0125 - Engine Coolant Temp Sensor Warm Up Fault  
P0130 - Oxygen Sensor Cycle Fault \*Codes\* A U  
P0131 - Oxygen Sensor Low Voltage \*Codes\* A U  
P0132 - Oxygen Sensor High Voltage \*Codes\* A U  
P0133 - Oxygen Sensor Slow Response \*Codes\* A U  
P0136 - Oxygen Sensor Cycle Fault \*Codes\* A D  
P0137 - Oxygen Sensor Low Voltage \*Codes\* A D  
P0138 - Oxygen Sensor High Voltage \*Codes\* A D  
P0139 - Oxygen Sensor Slow Response \*Codes\* A D  
P0150 - Oxygen Sensor Cycle Fault \*Codes\* B U  
P0151 - Oxygen Sensor Low Voltage \*Codes\* B U  
P0152 - Oxygen Sensor High Voltage \*Codes\* B U  
P0153 - Oxygen Sensor Slow Response \*Codes\* B U  
P0156 - Oxygen Sensor Cycle Fault \*Codes\* B D  
P0157 - Oxygen Sensor Low Voltage \*Codes\* B D  
P0158 - Oxygen Sensor High Voltage \*Codes\* B D  
P0159 - Oxygen Sensor Slow Response \*Codes\* B D  
P0171 - Oxygen Sensor System Too Lean Fault Bank A  
P0172 - Oxygen Sensor System Too Rich Fault Bank A  
P0174 - Oxygen Sensor System Too Lean Fault Bank B  
P0175 - Oxygen Sensor System Too Rich Fault Bank B  
P0181 - Fuel Temperature Sensor Signal Error Fault  
P0182 - Fuel Temperature Sensor Low Out of Range Fault  
P0183 - Fuel Temperature Sensor High Out of Range Fault  
P0201 - Injector 1 Circuit Fault  
P0202 - Injector 2 Circuit Fault  
P0203 - Injector 3 Circuit Fault  
P0204 - Injector 4 Circuit Fault  
P0205 - Injector 5 Circuit Fault  
P0206 - Injector 6 Circuit Fault  
P0207 - Injector 7 Circuit Fault  
P0208 - Injector 8 Circuit Fault  
P0300 - Misfire On Multiple Cylinder  
P0301 - Misfire Cylinder 1  
P0302 - Misfire Cylinder 2  
P0303 - Misfire Cylinder 3  
P0304 - Misfire Cylinder 4  
P0305 - Misfire Cylinder 5  
P0306 - Misfire Cylinder 6  
P0307 - Misfire Cylinder 7  
P0308 - Misfire Cylinder 8  
P0326 - Continuous Knock Fault Bank A  
P0327 - Background Noise Low Fault Bank A  
P0328 - Background Noise High Fault Bank A  
P0331 - Continuous Knock Fault Bank B  
P0332 - Background Noise Low Fault Bank B  
P0333 - Background Noise High Fault Bank B  
P0335 - Crankshaft Position Sensor Signal Error Fault  
P0336 - Crankshaft Position Sensor Out of Range Fault  
P0340 - Camshaft Position Sensor Signal Error Fault  
P0420 - Catalyst Efficiency Low Fault Bank A  
P0430 - Catalyst Efficiency Low Fault Bank B  
P0441 - Evap Purge Valve Incorrect Flow Fault  
P0442 - Evap System Small Leak Detected Fault  
P0443 - Evap Purge Valve Open or Short Circuit Fault  
P0451 - Fuel Tank Pressure Sensor Signal Error Fault  
P0452 - Fuel Tank Pressure Sensor Low out of Range Fault  
P0453 - Fuel Tank Pressure Sensor High Out of Range Fault  
P0461 - Fuel Tank Level Measurement Not Valid Fault  
P0500 - Vehicle Speed Sensor Signal Error Fault  
P0506 - Idle Speed Control Engine Speed Low Fault  
P0507 - Idle Speed Control Engine Speed High Fault  
P0560 - Battery Voltage Below Minimum Fault  
P0562 - Measurement Circuit OK Battery Voltage Low Fault  
P0563 - Battery Voltage Above Maximum Fault  
P0605 - ECM Self Test Fault

# GEMS

## GEMS-Specific Trouble Codes

# GEMS-Specific Trouble Codes

- 
- P1130 - Oxygen Sensor Fuel Trim at Limit \*Codes\* A U
  - P1131 - Oxygen Sensor Engine Lean \*Codes\* A U
  - P1132 - Oxygen Sensor Engine Rich \*Codes\* A U
  - P1137 - Oxygen Sensor Engine Lean \*Codes\* A D
  - P1138 - Oxygen Sensor Engine Rich \*Codes\* A D
  - P1150 - Oxygen Sensor Fuel Trim at Limit \*Codes\* B U
  - P1151 - Oxygen Sensor Engine Lean \*Codes\* B U
  - P1152 - Oxygen Sensor Engine Rich \*Codes\* B U
  - P1157 - Oxygen Sensor Engine Lean \*Codes\* B D
  - P1158 - Oxygen Sensor Engine Rich \*Codes\* B D
  - P1171 - Oxygen Sensor System Too Lean Fault Banks A & B
  - P1172 - Oxygen Sensor System Too Rich Fault Banks A & B
  - P1176 - Maximum Positive FMFR Correction Fault
  - P1177 - Maximum Negative FMFR Correction Fault
  - P1178 - Maximum Positive AMFR Correction Fault
  - P1179 - Maximum Negative AMFR Correction Fault
  - P1185 - Oxygen Sensor Heater Circuit Open Upstream
  - P1186 - Oxygen Sensor Heater Circuit Short Upstream
  - P1187 - Oxygen Sensor Heater Circuit Short Upstream
  - P1188 - Oxygen Sensor Heater High Resistance Upstream
  - P1189 - Oxygen Sensor Heater Type 1 Low Resistance Upstream
  - P1190 - Oxygen Sensor Heater Type 2 Low Resistance Upstream
  - P1191 - Oxygen Sensor Heater Circuit Open Downstream
  - P1192 - Oxygen Sensor Heater Circuit Short Downstream
  - P1193 - Oxygen Sensor Heater Circuit Open Downstream
  - P1194 - Oxygen Sensor Heater High Resistance Downstream
  - P1195 - Oxygen Sensor Heater Type 1 Low Resistance Downstream
  - P1196 - Oxygen Sensor Heater Type 2 Low Resistance Downstream
  - P1199 - Fuel Level Sensor Circuit Fault
  - P1201 - Injector 1 Open Circuit or Ground Short Fault
  - P1202 - Injector 2 Open Circuit or Ground Short Fault
  - P1203 - Injector 3 Open Circuit or Ground Short Fault
  - P1204 - Injector 4 Open Circuit or Ground Short Fault
  - P1205 - Injector 5 Open Circuit or Ground Short Fault
  - P1206 - Injector 6 Open Circuit or Ground Short Fault
  - P1207 - Injector 7 Open Circuit or Ground Short Fault
  - P1208 - Injector 8 Open Circuit or Ground Short Fault
  - P1313 - Misfire Catalyst Damage Fault Bank A
  - P1314 - Misfire Catalyst Damage Fault Bank B
  - P1315 - Misfire Persistent Fault
  - P1316 - Misfire Excessive Emissions Fault
  - P1317 - ABS Rough Road Line Low Fault
  - P1318 - ABS Rough Road Line High Fault
  - P1361 - No Ignition Coil Activation Fault Coil 1
  - P1362 - No Ignition Coil Activation Fault Coil 2
  - P1363 - No Ignition Coil Activation Fault Coil 3
  - P1364 - No Ignition Coil Activation Fault Coil 4
  - P1371 - Early Ignition Coil Activation Fault Coil 1
  - P1372 - Early Ignition Coil Activation Fault Coil 2
  - P1373 - Early Ignition Coil Activation Fault Coil 3
  - P1374 - Early Ignition Coil Activation Fault Coil 4
  - P1440 - Evap System Purge Valve Stuck Open Fault
  - P1441 - Evap System Purge Valve Flow 1 Fault
  - P1442 - Evap System Purge Valve Blocked Fault
  - P1447 - Evap System Purge Valve Open or Short Circuit Fault
  - P1448 - Evap System Purge Valve Flow 2 Fault
  - P1508 - Idle Speed Control Open Circuit Fault
  - P1509 - Idle Speed Control Short Circuit Fault
  - P1514 - Neutral Drive Load Fault
  - P1516 - Neutral Drive Gear Change Fault
  - P1517 - Neutral Drive Cranking Fault
  - P1607 - Malfunction Indicator Lamp Short Circuit Fault
  - P1608 - Malfunction Indicator Lamp Open Circuit Fault
  - P1620 - Reprogramming Code Learn Fault
  - P1621 - Serial Data Link Dead Fault
  - P1622 - Repeated Wrong ECM Security Code Fault
  - P1623 - ECM Security Code Fault
  - P1701 - Transfer Box Line Fault
  - P1703 - Transfer Box Line Open Circuit Fault
  - P1708 - Transfer Box Line Short Circuit Fault
  - P1775 - Gearbox Fault
  - P1776 - Gearbox Ignition Retard Request Timeout Fault
  - P1777 - Gearbox Ignition Retard Request Line Fault

# Copyright and Disclaimers

- This material may be distributed freely but may not be altered or sold for gain. It is copyrighted by David A. Poole (2004, 2005).
- The data and material in this document has been obtained from a number of sources including:
  - Land Rover and Rover workshop manuals.
  - Rovacom documentation.
  - A variety of web sources in the public domain.
  - Analysis of system operation.
  - The cover photograph was obtained from the Morgan Motor Company press site.
- This material is provided for the use in the maintenance of the GEMS system. David Poole does not warrant or assume any legal liability or responsibility for the accuracy, completeness, or usefulness of any information, apparatus, product, or process disclosed.
- Please contact me if you have any editorial inputs, additional material, questions or suggestions at:

David A. Poole  
974 Coachway Drive,  
Annapolis,  
Maryland 21401  
United States of America

T: 410.849.2882

F: 410.849.3192

M: 410.693.2561

[davidashleypoole@comcast.net](mailto:davidashleypoole@comcast.net)